

Service Manual



AFG310 and AFG320 Arbitrary Function Generator

071-0176-03

Warning

The servicing instructions are for use by qualified personnel only. To avoid personal injury, do not perform any servicing unless you are qualified to do so. Refer to the Safety Summary prior to performing service.



Copyright © Sony/Tektronix Corporation. All rights reserved.

Copyright © Tektronix, Inc. All rights reserved.

Tektronix products are covered by U.S. and foreign patents, issued and pending. Information in this publication supercedes that in all previously published material. Specifications and price change privileges reserved.

Printed in Japan.

Sony/Tektronix Corporation, 5-9-31 Kitashinagawa, Shinagawa-ku, Tokyo 141-0001 Japan

Tektronix, Inc., P.O. Box 500, Beaverton, OR 97077

TEKTRONIX and TEK are registered trademarks of Tektronix, Inc.

WARRANTY

Tektronix warrants that the products that it manufactures and sells will be free from defects in materials and workmanship for a period of three (3) years from the date of shipment. If a product proves defective during this warranty period, Tektronix, at its option, either will repair the defective product without charge for parts and labor, or will provide a replacement in exchange for the defective product.

In order to obtain service under this warranty, Customer must notify Tektronix of the defect before the expiration of the warranty period and make suitable arrangements for the performance of service. Customer shall be responsible for packaging and shipping the defective product to the service center designated by Tektronix, with shipping charges prepaid. Tektronix shall pay for the return of the product to Customer if the shipment is to a location within the country in which the Tektronix service center is located. Customer shall be responsible for paying all shipping charges, duties, taxes, and any other charges for products returned to any other locations.

This warranty shall not apply to any defect, failure or damage caused by improper use or improper or inadequate maintenance and care. Tektronix shall not be obligated to furnish service under this warranty a) to repair damage resulting from attempts by personnel other than Tektronix representatives to install, repair or service the product; b) to repair damage resulting from improper use or connection to incompatible equipment; c) to repair any damage or malfunction caused by the use of non-Tektronix supplies; or d) to service a product that has been modified or integrated with other products when the effect of such modification or integration increases the time or difficulty of servicing the product.

THIS WARRANTY IS GIVEN BY TEKTRONIX IN LIEU OF ANY OTHER WARRANTIES, EXPRESS OR IMPLIED. TEKTRONIX AND ITS VENDORS DISCLAIM ANY IMPLIED WARRANTIES OF MERCHANTABILITY OR FITNESS FOR A PARTICULAR PURPOSE. TEKTRONIX' RESPONSIBILITY TO REPAIR OR REPLACE DEFECTIVE PRODUCTS IS THE SOLE AND EXCLUSIVE REMEDY PROVIDED TO THE CUSTOMER FOR BREACH OF THIS WARRANTY. TEKTRONIX AND ITS VENDORS WILL NOT BE LIABLE FOR ANY INDIRECT, SPECIAL, INCIDENTAL, OR CONSEQUENTIAL DAMAGES IRRESPECTIVE OF WHETHER TEKTRONIX OR THE VENDOR HAS ADVANCE NOTICE OF THE POSSIBILITY OF SUCH DAMAGES.

Table of Contents

General Safety Summary	vii
Service Safety Summary	ix
Preface	xi
Introduction	xv

Specifications

Product Overview	1-1
Main Features	1-1
Specifications	1-3
Electrical Characteristic	1-3
Mechanical Characteristic	1-9
Environmental	1-10
Certification and Compliances	1-11

Operating Information

Installation	2-1
Operating Environment	2-1
Supplying Operating Power	2-3
Applying and Interrupting Power	2-8
Repackaging Instructions	2-9
Operating Instructions	2-11
Controls and Connectors	2-12
Basic Menu Operations	2-16

Theory of Operation

Module Overview	3-1
-----------------------	-----

Performance Verification

Conventions	4-1
Brief Procedures	4-2
Performance Tests	4-4
Prerequisites	4-4
Equipment Required	4-5
Output Waveform Test	4-6
Frequency Accuracy Test	4-9
Amplitude Accuracy Test	4-11
DC Voltage Accuracy Test	4-16
Operating Mode and Phase Test	4-18
Modulation Function Test	4-26

Adjustment Procedures

Maintenance

Maintenance	6-1
Related Maintenance Procedures	6-1
Preparation	6-2
Inspection and Cleaning	6-4
Troubleshooting	6-7
Power-on Diagnostics	6-7

Options and Accessories

Options and Accessories	7-1
Options	7-1
Standard Accessories	7-2
Optional Accessories	7-2

Diagrams

Electrical Parts List

Mechanical Parts List

Replaceable Mechanical Parts	10-1
Parts Ordering Information	10-1
Using the Replaceable Parts List	10-2

List of Figures

Figure 2–1: Cooling for rackmounted instrument(s)	2–2
Figure 2–2: Rear Panel Controls	2–4
Figure 2–3: POWER switch	2–8
Figure 2–4: Front panel controls	2–12
Figure 2–5: Rear panel	2–14
Figure 2–6: Default display	2–17
Figure 2–7: Menu item display	2–18
Figure 2–8: Item buttons and main menu buttons	2–18
Figure 2–9: Display example for a main menu selected	2–19
Figure 2–10: Display example for a numeric item selected	2–20
Figure 2–11: Buttons and keys for inputting numeric value	2–21
Figure 2–12: Example for inputting numeric value	2–21
Figure 2–13: Buttons for changing numeric value	2–22
Figure 2–14: CH button and channel indicators	2–24
Figure 4–1: Initial Test Hookup	4–6
Figure 4–2: Initial Test Hookup	4–9
Figure 4–3: Initial Test Hookup	4–11
Figure 4–4: Initial Test Hookup	4–19
Figure 4–5: 1 cycle, $\pm 180^\circ$ phase	4–22
Figure 4–6: 1 cycle, 0° phase ($\pm 360^\circ$)	4–22
Figure 4–7: 1 cycle, $+270^\circ$ phase (-90°)	4–23
Figure 4–8: 1 cycle, $+90^\circ$ phase (-270°)	4–23
Figure 4–9: 3 cycle, 0° phase (± 360)	4–24
Figure 4–10: 3 cycle, $+90^\circ$ phase (-270)	4–24
Figure 4–11: 3 cycle, $+180^\circ$ phase (-180)	4–25
Figure 4–12: 3 cycle, $+270^\circ$ phase (-90)	4–25
Figure 4–13: Initial Test Hookup	4–27
Figure 6–1: POWER switch	6–7
Figure 6–2: The LCD Display at Power On	6–8
Figure 6–3: The LCD display when an error is found	6–8
Figure 6–4: Troubleshooting procedure (1)	6–10
Figure 6–5: Troubleshooting procedure (2)	6–11
Figure 6–6: Troubleshooting procedure (3)	6–12
Figure 6–7: Connector location of A20 and A30 Board	6–13

Figure 6–8: Connector location of A10 and A40 Board	6–14
Figure 8–1: Block diagram	8–2
Figure 8–2: Interconnect diagram	8–3
Figure 10–1: Front Panel (AFG310)	10–4
Figure 10–2: Front Panel (AFG320)	10–5
Figure 10–3: Chassis (AFG310)	10–7
Figure 10–4: Chassis (AFG320)	10–9
Figure 10–5: Cabinet	10–10
Figure 10–6: Final (AFG320)	10–11

List of Tables

Table 1–1: Operating Mode	1–3
Table 1–2: Burst Count	1–3
Table 1–3: Waveforms	1–4
Table 1–4: Frequency	1–4
Table 1–5: Amplitude	1–4
Table 1–6: Offset	1–5
Table 1–7: Phase	1–5
Table 1–8: Main Output	1–6
Table 1–9: Modulation and Sweep	1–7
Table 1–10: Auxiliary Output	1–7
Table 1–11: Auxiliary Input	1–8
Table 1–12: Isolation	1–8
Table 1–13: Display	1–8
Table 1–14: AC Line Power	1–9
Table 1–15: Mechanical	1–9
Table 1–16: Environmental	1–10
Table 1–17: Installation Requirements	1–10
Table 1–18: Certifications and compliances	1–11
Table 2–1: Fuse and fuse cap part numbers	2–4
Table 2–2: Instrument voltage settings	2–5
Table 2–3: AC Line power requirements	2–6
Table 2–4: Voltage ranges and switch settings	2–6
Table 2–5: Power-cord conductor identification	2–7
Table 2–6: Power cord identification	2–7
Table 2–7: Numeric value input for Example 1	2–23
Table 2–8: Numeric value input for Example 2	2–24
Table 4–1: Self Test Requirements	4–2
Table 4–2: Calibration Test Requirements	4–3
Table 4–3: Test Equipment	4–5
Table 4–4: Output Waveform Test Requirements	4–6
Table 4–5: Oscilloscope settings	4–7
Table 4–6: AFG320 Output Waveform	4–8
Table 4–7: Frequency Accuracy Test Requirements	4–9
Table 4–8: Amplitude Accuracy Test Requirements	4–11

Table 4-9: DC Voltage Accuracy Test Requirements	4-16
Table 4-10: Operating Mode and Phase Test Requirements	4-19
Table 4-11: Oscilloscope settings	4-19
Table 4-12: Signal generator settings	4-21
Table 4-13: Modulation Function Test Requirements	4-26
Table 4-14: Oscilloscope settings	4-27
Table 6-1: Relative susceptibility to static-discharge damage	6-3
Table 6-2: External Inspection Check List	6-4
Table 6-3: Internal inspection check list	6-5
Table 7-1: Options	7-1
Table 7-2: Standard accessories	7-2
Table 7-3: Optional accessories	7-2

General Safety Summary

Review the following safety precautions to avoid injury and prevent damage to this product or any products connected to it. To avoid potential hazards, use this product only as specified.

Only qualified personnel should perform service procedures.

To Avoid Fire or Personal Injury

Use Proper Power Cord. Use only the power cord specified for this product and certified for the country of use.

Connect and Disconnect Properly. Do not connect or disconnect probes or test leads while they are connected to a voltage source.

Ground the Product. This product is grounded through the grounding conductor of the power cord. To avoid electric shock, the grounding conductor must be connected to earth ground. Before making connections to the input or output terminals of the product, ensure that the product is properly grounded.

Observe All Terminal Ratings. To avoid fire or shock hazard, observe all ratings and markings on the product. Consult the product manual for further ratings information before making connections to the product.

The common terminal is at ground potential. Do not connect the common terminal to elevated voltages.

Do not apply a potential to any terminal, including the common terminal, that exceeds the maximum rating of that terminal.

Do Not Operate Without Covers. Do not operate this product with covers or panels removed.

Use Proper Fuse. Use only the fuse type and rating specified for this product.

Avoid Exposed Circuitry. Do not touch exposed connections and components when power is present.

Do Not Operate With Suspected Failures. If you suspect there is damage to this product, have it inspected by qualified service personnel.

Do Not Operate in Wet/Damp Conditions.

Do Not Operate in an Explosive Atmosphere.

Keep Product Surfaces Clean and Dry.

Provide Proper Ventilation. Refer to the manual's installation instructions for details on installing the product so it has proper ventilation.

Symbols and Terms

Terms in this Manual. These terms may appear in this manual:



WARNING. *Warning statements identify conditions or practices that could result in injury or loss of life.*



CAUTION. *Caution statements identify conditions or practices that could result in damage to this product or other property.*

Terms on the Product. These terms may appear on the product:

DANGER indicates an injury hazard immediately accessible as you read the marking.

WARNING indicates an injury hazard not immediately accessible as you read the marking.

CAUTION indicates a hazard to property including the product.

Symbols on the Product. The following symbols may appear on the product:



WARNING
High Voltage



Protective Ground
(Earth) Terminal



CAUTION
Refer to Manual



Double
Insulated

Service Safety Summary

Only qualified personnel should perform service procedures. Read this *Service Safety Summary* and the *General Safety Summary* before performing any service procedures.

Do Not Service Alone. Do not perform internal service or adjustments of this product unless another person capable of rendering first aid and resuscitation is present.

Disconnect Power. To avoid electric shock, disconnect the mains power by means of the power cord or, if provided, the power switch.

Use Care When Servicing With Power On. Dangerous voltages or currents may exist in this product. Disconnect power, remove battery (if applicable), and disconnect test leads before removing protective panels, soldering, or replacing components.

To avoid electric shock, do not touch exposed connections.

Preface

This preface contains information needed to properly use this manual to service the AFG310 and AFG320 Arbitrary Function Generators

Manual Structure

This manual is divided into sections, such as *Specifications* and *Theory of Operation*. Further, some sections are divided into subsections, such as *Product Overview* and *Self Test and Calibration Procedure*.

Sections containing procedures also contain introductions to those procedures. Be sure to read these introductions because they provide information needed to do the service correctly and efficiently. The following contains a brief description of each manual section.

- *Specifications* contains a description of the function generator and the characteristics that apply to it.
- *Operating Information* includes general information and operating instructions.
- *Theory of Operation* contains circuit descriptions that support service to the module level.
- *Performance Verification* contains procedures for confirming that the function generator functions properly and meets warranted limits.
- *Adjustment Procedures* contains a statement explaining that adjustment is unnecessary for the function generator.
- *Maintenance* contains information and procedures for performing preventive and corrective maintenance of the function generator. These instructions include cleaning, and fault isolation to the module.
- *Options* contains information on servicing factory-installed options.
- *Electrical Parts List* contains a statement referring you to *Mechanical Parts List*, where both electrical and mechanical modules are listed.
- *Diagrams* contains block diagrams and an interconnection diagram.
- *Mechanical Parts List* includes a table of all replaceable modules, their descriptions, and their Tektronix part numbers.

Manual Conventions

This manual uses certain conventions that you should become familiar with.

Some sections of the manual contain procedures for you to perform. To keep those instructions clear and consistent, this manual uses the following conventions:

- Names appear in the same case (all uppercase) and the same abbreviation as is used on the Arbitrary Function Generator front panel, buttons, and menus.
- Instruction steps are numbered. The number is omitted if there is only one step. Some instruction steps have substeps listed in alphabetical order.
- When steps require that you make a sequence of selections using front panel buttons, an arrow (→) marks each transition between front panel buttons:

CH → FUNC → > to display TRIA

Using the convention just described results in instructions that are graphically intuitive and simplifies the procedures. For example, the instruction just given replaces these three steps:

1. Press the front panel button CH.
2. Press the front panel button FUNC.
3. Repeatedly press the front panel button > until TRIA is displayed on the LCD (liquid crystal display).

This manual also shows instrument setups using tables. For example, the *Operating Information* section uses tables to show specific setups.

The header of each table contains names of button groups that represent the controls, menus, and items used to set up the instrument. To make a specific setup, read the table from left to right and then from top to bottom as shown below. The table contains the symbol “—” if no action is required.

Main Button	Control Button Or Numeric Input Key	
	First Level in the Menu Layers	Second Level in the Menu Layers
	2. Press the < or > button several times to display the desired item. 3. Press the ENTER button to confirm your selection.	4. For the selection, press the ^ or v button several times to display the desired selection. 5. Press the numeric keys to input value. 6. Press the ENTER or the Unit button to confirm your selection or numeric input.
7	8.	
—	10.	11.
—	—	12. Press the EXIT button to move to the upper level in the menu layer.
—	13. Press the EXIT button to move to the default display.	—

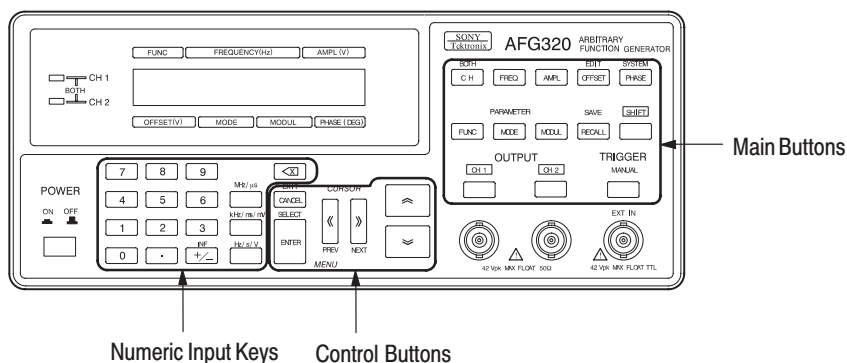

Default Model

This manual documents the AFG310 and AFG320 Arbitrary Function Generators. However, the AFG320 Arbitrary Function Generator display (liquid crystal display) appears as the default display whenever a display is illustrated in this manual.

Modules Throughout this manual, any replaceable component, assembly, or any part of the AFG310 and AFG320 Arbitrary Function Generators is referred to as a module. In general, a module is an assembly, like a circuit board, rather than a component, like a resistor or an integrated circuit. Sometimes a single component is a module; for example, each chassis part of the instrument is a module.

Safety Symbols and terms related to safety appear in the *Safety Summary* near the beginning of this manual.

Related Manuals

Other documentation for the AFG310 and AFG320 Arbitrary Function Generators includes:

- The *AFG310 and AFG320 Arbitrary Function Generator User Manual* contains a tutorial to quickly describe how to operate the function generator. It also includes an in-depth discussion on how to more completely use the function generator features.
- The *AFG300 Series Programmer Manual* explains how to use a GPIB interface to remotely control the function generator.

Introduction

Service Strategy

This manual contains all the information needed for periodic maintenance of the AFG310 and AFG320 Arbitrary Function Generator. Further, it contains all information for corrective maintenance down to the module level. To isolate a failure to a module, refer to the *Maintenance* section. After isolating a faulty module, replace it with a fully-tested module obtained from the factory. The *Mechanical Parts List* section contains part numbers and ordering information for all replaceable modules.

Throughout this manual, the term, module, refers to any field-replaceable component, assembly, or part of the AFG310 and AFG320 Arbitrary Function Generator.

Service Offerings

Tektronix provides service to cover repair under warranty as well as other services that may provide a cost-effective answer to your service needs.

Whether providing warranty repair service or any of the other services listed below, Tektronix service technicians are well equipped to service the AFG310 and AFG320 Arbitrary Function Generator. Tektronix technicians train on Tektronix products; they have access to the latest information on improvements to the AFG310 and AFG320 Arbitrary Function Generators as well as new options.

Warranty Repair Service

Tektronix warrants this product for three years from date of purchase. The warranty appears on the back of the title page in this manual. Tektronix technicians provide warranty service at most Tektronix service locations. The Tektronix product catalog lists all worldwide service locations.

Self Service

Tektronix supports repair to the module level by providing Module Exchange.

Module Exchange. This service reduces down-time for repair by allowing you to exchange most modules for remanufactured ones. Each module comes with a 90-day service warranty.

For More Information. Contact your local Tektronix service center or sales engineer for more information on any of the repair or adjustment services just described.

Performance Check Interval

Generally, the performance check described in the *Performance Verification* section should be done every 12 months. In addition, a performance check is recommended after module replacement.

If the AFG310 and AFG320 Arbitrary Function Generator does not meet performance criteria, repair is necessary.

Before You Begin

To prevent personal injury or damage to the AFG310 and AFG320 Arbitrary Function Generators, do the following tasks before you attempt to service:

- Be sure you are a qualified service person
- Read the *General Safety Summary* and the *Service Safety Summary*, beginning on page vii
- Read the *Operating Information* section

When using this manual for servicing, be sure to follow all warnings, cautions, and notes.

Contacting Tektronix

Product Support	<p>For application-oriented questions about a Tektronix measurement product, call toll free in North America: 1-800-TEK-WIDE (1-800-835-9433 ext. 2400) 6:00 a.m. – 5:00 p.m. Pacific time</p> <p>Or contact us by e-mail: tm_app_supp@tek.com</p> <p>For product support outside of North America, contact your local Tektronix distributor or sales office.</p>
Service Support	<p>Contact your local Tektronix distributor or sales office. Or visit our web site for a listing of worldwide service locations.</p> <p>http://www.tek.com</p>
For other information	<p>In North America: 1-800-TEK-WIDE (1-800-835-9433) An operator will direct your call.</p>
To write us	<p>Tektronix, Inc. P.O. Box 500 Beaverton, OR 97077</p>



Specifications

Product Overview

The Arbitrary Function Generators are portable waveform generators equipped with both arbitrary waveform editing functions and standard waveform generator functions. The AFG310 Arbitrary Function Generator is a single-channel output model, and the AFG320 Arbitrary Function Generator is a two-channel output model.

Main Features

Following are the main features of the AFG310 Arbitrary Function Generators:

- Seven types of standard function waveforms:
Sine, Square, Triangle, Ramp, Pulse, DC, and Noise
- Maximum output frequency is 16 MHz
- 50 Ω impedance floating output
- Three operating modes:
Continuous, Triggered, and Burst
- Four types of modulation functions:
Sweep function, FM modulation, FSK modulation, and AM modulation
- Creating and editing waveforms by edit functions and equipped with four user waveform memories
- 20 setup memories
Saving and recalling setup in the memory; step recall mode is selectable for recalling
- A standard GPIB interface that controls the instrument through the interface and imports waveforms from other instruments

Specifications

This section contains the AFG310 and AFG320 Arbitrary Function Generator specifications. All specifications are guaranteed unless labeled “typical.” Typical specifications are provided for your convenience but are not guaranteed.

Performance Conditions

The performance limits in this specification are valid with these conditions:

- The function generator must have been calibrated/adjusted at an ambient temperature between +20° C and +30° C.
- The function generator must be in an environment with temperature, altitude, humidity, and vibration within the operating limits described in these specifications.
- The function generator must have had a warm-up period of at least 20 minutes.
- The function generator must be operating at an ambient temperature between +10° C and +40° C.

Electrical Characteristic

Table 1-1: Operating Mode

Name	Description
Continuous	Generates the waveform continuously.
Triggered	Output quiescent until triggered by an external, GPIB, or manual trigger, then generates a waveform only one time.
Burst	Output quiescent until triggered by an external, GPIB, or manual trigger, then generates waveform predefined count.

Table 1-2: Burst Count

Name	Description
Burst Count	1 to 60 000, or Infinite (Sine or square wave output will stop 100 seconds after the output starts, even if the specified burst count has not been reached.)
Resolution	1

Table 1-3: Waveforms

Name	Description
Standard Waveforms	Sine, Square, Triangle, Ramp, Pulse, Noise, DC
Arbitrary Waveforms	
Point Length	10 to 16384
Vertical Resolution	12 bits
Number of Waveforms	4

Table 1-4: Frequency

Name	Description	
Frequency Range	Operating Mode:	Frequency Range:
Sine, Square	Continuous Mode	10 mHz to 16 MHz
	Triggered/Burst Mode	10 mHz to 1 MHz
Triangle, Ramp, Pulse	10 mHz to 100 kHz	
Noise	5 MHz Bandwidth at 16 MS/s (Megasamples/Second)	
User Waveforms, Edit Waveform	10 mHz to 1.6 MHz	
Frequency Resolution	10 mHz or 7 digits	
Frequency Accuracy	± 50 ppm	

Table 1-5: Amplitude

Name	Description
Amplitude	
Range	505 mV _{p-p} to 10 V _{p-p} into 50 Ω (The absolute peak amplitude plus the offset is limited to +5 V or -5 V)
	50 mV _{p-p} to 500 mV _{p-p} into 50 Ω
Resolution	5 mV
Accuracy	± (1 % of Amplitude + 5 mV) at 1 kHz with no offset
Impedance	50 Ω

Table 1-6: Offset

Name	Description	
Offset Range	Amplitude Range: 505 mV _{p-p} to 10 V _{p-p} 50 mV _{p-p} to 500 mV _{p-p}	Offset Range: The absolute peak amplitude plus the offset is limited to +5 V or -5 V into 50 Ω -0.75 V to +0.75 V into 50 Ω
Resolution	5 mV	
Accuracy	± (1 % of Offset + 5 mV)	

Table 1-7: Phase

Name	Description	
Phase Range Sine, Square	Operating Mode and Output Frequency: Continuous Mode Triggered/Burst, $f \leq 100$ kHz Triggered/Burst, $100 \text{ kHz} < f \leq 1 \text{ MHz}$	Phase Range: $\pm 360^\circ$ $\pm 360^\circ$ 0° Fixed
Triangle, Ramp, Pulse, User Waveforms, Edit Waveform	Continuous Mode Triggered/Burst	0° Fixed $\pm 360^\circ$
Phase Resolution Sine, Square Triangle, Ramp, Pulse User Waveforms, Edit Waveform	Restriction: No restrictions Output_Frequency ≤ 2 kHz Waveform_Length ≥ 360 points	Phase Resolution: 1° 1° 1°
Offset Phase Accuracy, typical (Sine Wave, Amplitude 1 V, No Offset at Phase 0°)	Frequency Range: Less than 10 kHz 10 kHz to 100 kHz	Accuracy: $\pm 0.1^\circ$ $\pm 0.2^\circ$

Table 1-8: Main Output

Name	Description										
Sine Wave											
Flatness, relative to 1 kHz at Amplitude 1.2 V _{p-p}	<table border="1"> <tr> <td>Frequency Setting:</td> <td>Flatness Range:</td> </tr> <tr> <td>Less than 100 kHz</td> <td>± 1 %</td> </tr> <tr> <td>100 kHz to 1 MHz</td> <td>± 1.5 %</td> </tr> <tr> <td>1 MHz to 16 MHz</td> <td>± 3 %</td> </tr> </table>	Frequency Setting:	Flatness Range:	Less than 100 kHz	± 1 %	100 kHz to 1 MHz	± 1.5 %	1 MHz to 16 MHz	± 3 %		
Frequency Setting:	Flatness Range:										
Less than 100 kHz	± 1 %										
100 kHz to 1 MHz	± 1.5 %										
1 MHz to 16 MHz	± 3 %										
Harmonic Distortion, at Amplitude 1 V _{p-p}	<table border="1"> <tr> <td>Frequency Setting:</td> <td>Harmonic Distortion:</td> </tr> <tr> <td>DC to 20 kHz</td> <td>-70 dBc</td> </tr> <tr> <td>20 kHz to 100 kHz</td> <td>-60 dBc</td> </tr> <tr> <td>100 kHz to 1 MHz</td> <td>-45 dBc</td> </tr> <tr> <td>1 MHz to 16 MHz</td> <td>-35 dBc</td> </tr> </table>	Frequency Setting:	Harmonic Distortion:	DC to 20 kHz	-70 dBc	20 kHz to 100 kHz	-60 dBc	100 kHz to 1 MHz	-45 dBc	1 MHz to 16 MHz	-35 dBc
Frequency Setting:	Harmonic Distortion:										
DC to 20 kHz	-70 dBc										
20 kHz to 100 kHz	-60 dBc										
100 kHz to 1 MHz	-45 dBc										
1 MHz to 16 MHz	-35 dBc										
typical											
typical											
Total Harmonic Distortion, at Amplitude 1 V and 20 kHz	0.05 %										
Spurious (non harmonic) typical	-55 dBc at 10 MHz										
Phase Noise typical	-90 dBc/Hz, at 10 MHz Carrier Wave with 10 kHz offset										
Subharmonic typical	-50 dBc										
Cross Talk between Channels											
typical	Less than -70 dBc, Only AFG320 (Sine Wave, 1 MHz, Amplitude 1 V, No Offset)										
Square Wave Pulse Response											
Rise/Fall Time	Less than 20 ns										
Overshoot	Less than 2 %										
Triangle, Ramp, Pulse, User Waveforms, Edit Waveform Response, typical											
Rise/Fall Time	less than 100 ns										
Pulse Duty											
Range	1 % to 99 %										
Resolution	1 %										
Jitter, typical	2 ns, at 100 kHz										
DC											
Range	-5 V to +5 V into 50 Ω										
Resolution	5 mV										
DC Accuracy	± (1 % of DC volts + 5 mV)										

Table 1-9: Modulation and Sweep

Name	Description
FM Modulation	
Modulation Signals	Sine, Square, Triangle, Ramp, User Waveforms, Edit Waveform
Modulating Frequency	10 mHz to 10 kHz
Resolution	4 digits
Peak Deviation	10 mHz to 8 MHz
Resolution	7 digits
FSK Modulation	
Modulating Frequency	10 mHz to 16 MHz
Key Rate	10 mHz to 50 kHz
Resolution	4 digits
Numbers of Key	2
Sweep	
Spacing	Linear or Log
Direction	Up or Down
Start/Stop Frequency	
Sine, Square	10 mHz to 16 MHz
Triangle, Ramp, Pulse	10 mHz to 100 kHz
User Waveforms, Edit Waveform	10 mHz to 1.6 MHz
Resolution	5 digits
Sweep Time	1 ms to 100 s
Resolution	4 digits

Table 1-10: Auxiliary Output

Name	Description
CH1 SYNC Output	
Output Level	Positive TTL Level Pulse
Impedance	50 Ω
Pulse width	25 ns minimum

Table 1-11: Auxiliary Input

Name	Description						
AM Input							
Range, typical	2 V _{p-p} (± 0.2 V Tolerance) for 100 % modulation External signal +1 V for 100 % modulation level 0 V for 50 % modulation level -1 V for 0 % modulation level						
Impedance	10 kΩ						
Maximum Input	± 5 V (DC plus peak AC)						
Frequency Response							
Ext Signal	DC to 200 kHz (-3 dB)						
Trigger/Burst Input							
Input Level	TTL Level Compatible						
Pulse Width	1 μs minimum						
Impedance	10 kΩ						
Maximum Input	Equal and Less than 5 V						
Trigger to Signal Delay	Less than 1 μs with sine wave						
Trigger Holdoff	<table border="0"> <tr> <td>Restriction:</td> <td>Holdoff Time:</td> </tr> <tr> <td> Standard Waves(except phased Square), User Waveforms, Edit Waveform</td> <td>5 μs maximum</td> </tr> <tr> <td> Square Wave at Phase ≠ 0°</td> <td>5 μs maximum + 1.5 cycles</td> </tr> </table>	Restriction:	Holdoff Time:	Standard Waves(except phased Square), User Waveforms, Edit Waveform	5 μs maximum	Square Wave at Phase ≠ 0°	5 μs maximum + 1.5 cycles
Restriction:	Holdoff Time:						
Standard Waves(except phased Square), User Waveforms, Edit Waveform	5 μs maximum						
Square Wave at Phase ≠ 0°	5 μs maximum + 1.5 cycles						

Table 1-12: Isolation

Name	Description
Isolation	42 Vpk maximum relative to earth ground.

Table 1-13: Display

Name	Description
Display	LCD (20 Characters × 2 Lines)

Table 1-14: AC Line Power

Name	Description
Line Frequency Range	
90 V to 250 V AC	48.0 Hz to 63.0 Hz
90 V to 127 V AC	48.0 Hz to 440 Hz
Maximum Power Consumption	70 W
Maximum Current	2 A
Line Voltage Range	Cat II
⚠ 115 V	
High	108 V to 132 V AC
Low	90 V to 110 V AC
230 V	
High	216 V to 250 V AC
Low	180 V to 220 V AC
Fuse Rating	1 A Fast, 250 V, UL 198G (3 AG) 0.5 A (T), 250 V, IEC 127

Mechanical Characteristic

Table 1-15: Mechanical

Name	Description
Weight	
Standard	5.4 kg (AFG310) 5.6 kg (AFG320)
Dimensions	
Height	99 mm (3.9 in), with the feet
Width	214 mm (8.4 in)
Depth	411 mm (16.2 in)

Environmental

Table 1-16: Environmental

Name	Description
Atmospherics	
Temperature	Operating: 0° C to +50° C Nonoperating: -20° C to +60° C
Relative humidity	Operating: 0 % to 95 %, at or below +40° C, Operating: 0 % to 75 %, +40° C to +50° C
Altitude	Operating: Up to 4.5 km (15,000 ft.), (Maximum operating temperature decreases 1° C each 300 m above 1.5 km.) Nonoperating: Up to 15 km (50,000 ft.)
Dynamics	
Random vibration	Operating: 0.31 g rms, from 5 to 500 Hz, 10 minutes each axis Nonoperating: 2.46 g rms, from 5 to 500 Hz, 10 minutes each axis
Shock	Nonoperating: 294 m/s ² (30 G), Half-sine, 11 ms duration Three shocks per axis in each direction (18 shocks total)

Table 1-17: Installation Requirements

Name	Description
Installation Requirements	
Maximum Power Dissipation (Fully Loaded)	70 W, Maximum line current is 2 A at 90 V line and 50 Hz.
Surge Current	12 A (25° C) peak for ≤ 5 line cycles, after product has been turned off for at least 30 s.
Cooling Clearance	5 cm (2 in) Top even Rackmounted type 5 cm (2 in) Rear

Certification and Compliances

The certification and compliances for the AFG310 and AFG320 Arbitrary Function Generator are listed in Table 1–18.

Table 1–18: Certifications and compliances

Category	Standards or description								
EC Declaration of Conformity – EMC	<p>Meets intent of Directive 89/336/EEC for Electromagnetic Compatibility. Compliance was demonstrated to the following specifications as listed in the Official Journal of the European Communities:</p> <p>EMC Directive 89/336/EEC:</p> <table> <tr> <td>EN 55011</td> <td>Class A Radiated and Conducted Emissions</td> </tr> <tr> <td>EN 50081-1 Emissions: EN60555-2</td> <td>AC Power Line Harmonic Emissions</td> </tr> <tr> <td>EN 50082-1 Immunity: IEC801-2 IEC801-3 IEC801-4 IEC801-5</td> <td>Electrostatic Discharge Immunity RF Electromagnetic Field Immunity Electrical Fast Transient/Burst Immunity Power Line Surge Immunity</td> </tr> </table>	EN 55011	Class A Radiated and Conducted Emissions	EN 50081-1 Emissions: EN60555-2	AC Power Line Harmonic Emissions	EN 50082-1 Immunity: IEC801-2 IEC801-3 IEC801-4 IEC801-5	Electrostatic Discharge Immunity RF Electromagnetic Field Immunity Electrical Fast Transient/Burst Immunity Power Line Surge Immunity		
EN 55011	Class A Radiated and Conducted Emissions								
EN 50081-1 Emissions: EN60555-2	AC Power Line Harmonic Emissions								
EN 50082-1 Immunity: IEC801-2 IEC801-3 IEC801-4 IEC801-5	Electrostatic Discharge Immunity RF Electromagnetic Field Immunity Electrical Fast Transient/Burst Immunity Power Line Surge Immunity								
Australian/New Zealand declaration of Conformity - EMC	<p>Complies with EMC provision of Radio–communications Act per the following standard:</p> <table> <tr> <td>AS/NZS 2064.1/2</td> <td>Industrial, Scientific, and Medical Equipment: 1992</td> </tr> </table>	AS/NZS 2064.1/2	Industrial, Scientific, and Medical Equipment: 1992						
AS/NZS 2064.1/2	Industrial, Scientific, and Medical Equipment: 1992								
EC Declaration of Conformity – Low Voltage	<p>Compliance was demonstrated to the following specification as listed in the Official Journal of the European Communities:</p> <p>Low Voltage Directive 73/23/EEC, amended by 93/68/EEC</p> <table> <tr> <td>EN 61010-1/A2:1995</td> <td>Safety requirements for electrical equipment for measurement, control and laboratory use.</td> </tr> </table>	EN 61010-1/A2:1995	Safety requirements for electrical equipment for measurement, control and laboratory use.						
EN 61010-1/A2:1995	Safety requirements for electrical equipment for measurement, control and laboratory use.								
Approvals	<p>Complies with the following safety standards:</p> <table> <tr> <td>UL3111–1, First Edition</td> <td>Standard for electrical measuring and test equipment.</td> </tr> <tr> <td>CAN/CSA C22.2 No.1010.1-92</td> <td>Safety requirements for electrical equipment for measurement, control and laboratory use.</td> </tr> </table>	UL3111–1, First Edition	Standard for electrical measuring and test equipment.	CAN/CSA C22.2 No.1010.1-92	Safety requirements for electrical equipment for measurement, control and laboratory use.				
UL3111–1, First Edition	Standard for electrical measuring and test equipment.								
CAN/CSA C22.2 No.1010.1-92	Safety requirements for electrical equipment for measurement, control and laboratory use.								
Installation Category	<p>CAT II</p> <p>Terminals on this product may have different installation (over–voltage) category designations. The installation categories are:</p> <table> <tr> <td>Category</td> <td>Examples of products in this category</td> </tr> <tr> <td>CAT III</td> <td>Distribution-level mains (usually permanently connected). Equipment at this level is typically in a fixed industrial location.</td> </tr> <tr> <td>CAT II</td> <td>Local-level mains (wall sockets). Equipment at this level includes appliances, portable tools, and similar products. Equipment is usually cord-connected.</td> </tr> <tr> <td>CAT I</td> <td>Secondary (signal level) or battery operated circuits of electronic equipment.</td> </tr> </table>	Category	Examples of products in this category	CAT III	Distribution-level mains (usually permanently connected). Equipment at this level is typically in a fixed industrial location.	CAT II	Local-level mains (wall sockets). Equipment at this level includes appliances, portable tools, and similar products. Equipment is usually cord-connected.	CAT I	Secondary (signal level) or battery operated circuits of electronic equipment.
Category	Examples of products in this category								
CAT III	Distribution-level mains (usually permanently connected). Equipment at this level is typically in a fixed industrial location.								
CAT II	Local-level mains (wall sockets). Equipment at this level includes appliances, portable tools, and similar products. Equipment is usually cord-connected.								
CAT I	Secondary (signal level) or battery operated circuits of electronic equipment.								

Table 1-18: Certifications and compliances (cont.)

Category	Standards or description
Pollution Degree	<p>A measure of the contaminates that could occur in the environment around and within a product. Typically the internal environment inside a product is considered to be the same as the external. Products should be used only in the environment for which they are rated.</p> <p>Pollution Degree 2 Normally only dry, nonconductive pollution occurs. Occasionally a temporary conductivity that is caused by condensation must be expected. This location is a typical office/home environment. Temporary condensation occurs only when the product is out of service.</p>
Conditions of Approval	<p>Safety Certifications/Compliances are made for the following conditions:</p> <p>Temperature (operation): +5 °C to +40 °C</p> <p>Altitude (maximum operation): 2000 meters</p>
IEC Characteristics	<p>Equipment type:</p> <p>Test and Measuring</p> <p>Installation Category II (as defined in IEC 61010-1, Annex J)</p> <p>Pollution Degree 2 (as defined in IEC 61010-1)</p> <p>Safety Class I (as defined in IEC 61010-1, Annex H)</p>



Operating Information

Installation

This subsection describes the installation, environmental requirements, and information on how to power on and off. The information describes the following items:

- Operating Environment
- Supplying Operating Power
- Applying and Interrupting Power

Operating Environment

The following environmental requirements are provided to ensure proper operation and long instrument life.

Operating Temperature

Operate the AFG310 and AFG320 Arbitrary Function Generator where the ambient air temperature is from 0° C to +50° C. Store the instrument in ambient temperatures from -20° C to +60° C. After storage at temperatures outside the operating limits, allow the chassis to stabilize to a safe operating temperature before applying power.



CAUTION. *Damage to the instrument can occur if this instrument is powered on at temperatures outside the usage temperature range.*

Ventilation Requirements

The instrument is cooled by air drawn in through the air intakes at the top and exhausted through the rear of the instrument by an internal fan. To ensure proper cooling of the instrument, verify that the air intake holes on the top of the instrument and exhaust holes on the rear of the instrument are not obstructed. Allow at least 5 cm (2 inches) of clearance on the top and the rear of the instrument.

When you install a second instrument above the AFG310 and AFG320 Arbitrary Function Generators, leave at least 5 cm (2 inches) of clearance between the instruments. See Figure 2-1.

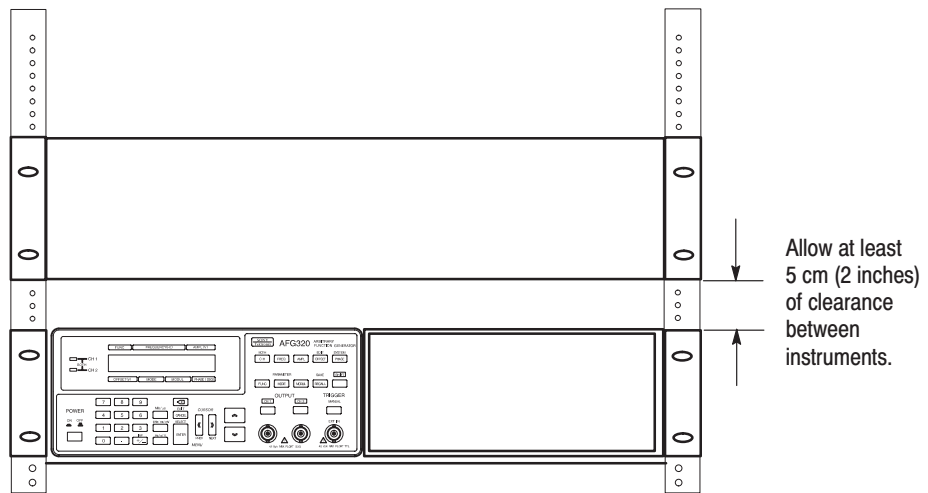

Figure 2-1: Cooling for rackmounted instrument(s)

Supplying Operating Power

NOTE. Read all information and heed all warnings in this subsection before connecting the AFG310 and AFG320 Arbitrary Function Generators to a power source.



WARNING. AC POWER SOURCE AND CONNECTION. The AFG310 and AFG320 Arbitrary Function Generators operate from a single-phase power source. They have a three-wire power cord and two-pole, three-terminal grounding type plug. The voltage to ground (earth) from either pole of the power source must not exceed the maximum rated operating voltage, 250 volts.

Before making connection to the power source, be sure the AFG310 and AFG320 Arbitrary Function Generators have a suitable two-pole, three-terminal grounding-type plug.

GROUNDING. This instrument is safety Class 1 equipment (IEC designation). All accessible conductive parts are directly connected through the grounding conductor of the power cord to the grounded (earthing) contact of the power plug.



WARNING. The power input plug must be inserted only in a mating receptacle with a grounding contact where earth ground has been verified by a qualified service person. Do not defeat the grounding connection. Any interruption of the grounding connection can create an electric shock hazard.

For electric shock protection, the grounding connection must be made before making connection to the instrument's input or output terminals.

Operating Voltage

This instrument operates with any line voltage from 100 VAC_{RMS} to 240 VAC_{RMS} with any line frequency from 48 Hz to 63 Hz. There are two fuses, either of which may be used throughout the line voltage and frequency ranges. (The two fuses are not interchangeable as each requires a different fuse cap.)

Fuse Type and Rating

The AFG310 and AFG320 Arbitrary Function Generator uses the same fuse for the entire operating line voltage range. Refer to Table 2–1 for fuse and fuse cap information.



WARNING. To avoid electrical shock, be sure that the power cord is disconnected before checking the fuse.

To remove the fuse, push in and turn the fuse holder cap counterclockwise with a screwdriver. See Figure 2–2 for the fuse location.

NOTE. The instrument order specified either a UL approved or an IEC approved fuse. Each fuse requires its own cap. See Table 2–1. The fuse approved under the IEC standards is used in equipment sold in the European market.

Table 2-1: Fuse and fuse cap part numbers

Fuse	Tektronix Fuse Part Number	Fuse Cap Part Number
0.25 inch × 1.25 inch (UL 198.6, 3 AG): 1 A fast, 250 V	159-0022-01	200-2264-00
5 mm × 20 mm (IEC 127): 0.5 A (T), 250 V	159-0413-00	200-2265-00

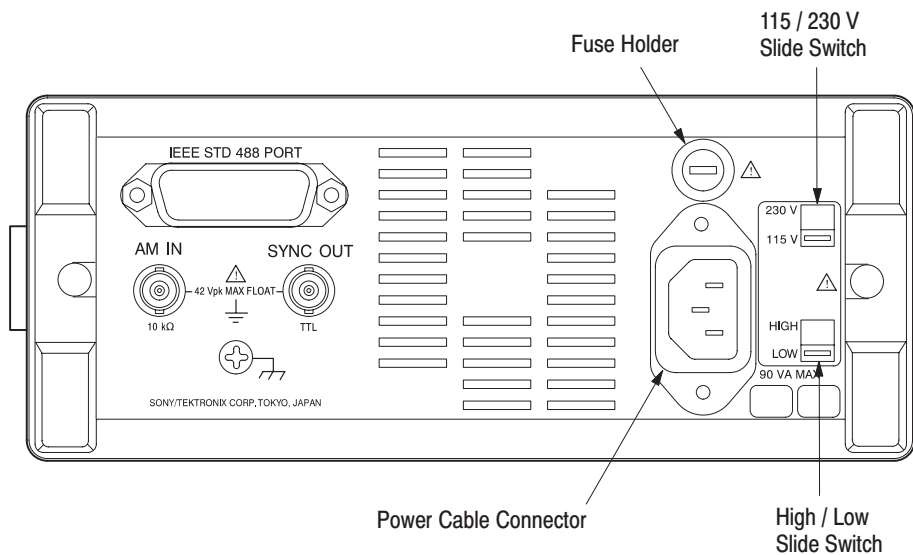

Figure 2-2: Rear Panel Controls

Check Voltage Settings

Check that you have the proper electrical connections. The instrument requires 90 VAC_{RMS} to 250 VAC_{RMS}, 48 Hz to 440 Hz, and may require up to 70 W.

The instrument voltage setting must be adapted to power source voltage. See Table 2-2 for switch settings.

Table 2-2: Instrument voltage settings

115/230 Switch	High/Low Switch	Power Source
115 V	Low	90 V to 110 V
115 V	High	108 V to 132 V
230 V	Low	180 V to 220 V
230 V	High	216 V to 250 V

Table 2–3 contains information for the AFG310 and AFG320 Arbitrary Function Generators power requirements.

Table 2–3: AC Line power requirements

















Name	Description
Line Frequency Range: 48.0 Hz to 63.0 Hz 48.0 Hz to 440 Hz	VAC _{RMS} : 127 V to 250 V 90 V to 127 V
Maximum Power Consumption	70 W
Maximum Current	2 A



CAUTION. To avoid damaging the instrument, be sure that the power cord is disconnected before changing the voltage setting.

Check the voltage settings on the two slide switches on the rear panel. The correspondence between the voltage ranges and the switch settings for those ranges is shown in Table 2–4. Refer to Figure 2–2 for the switch locations.

Table 2–4: Voltage ranges and switch settings

Voltage Range	90 V ~ 110 V	108 V ~ 132 V	180 V ~ 220 V	216 V ~ 250 V
115 V / 230 V Voltage Switch	230 V  115 V 	230 V  115 V 	230 V  115 V 	230 V  115 V 
High / Low Range Switch	High  Low 	High  Low 	High  Low 	High  Low 

Power Cord Information

A power cord with the appropriate plug configuration is supplied with each AFG310 and AFG320 Arbitrary Function Generator. Table 2-5 gives the color-coding of the conductors in the power cord. If you require a power cord other than the one supplied, refer to Table 2-6: Power Cord Identification.

Table 2-5: Power-cord conductor identification

Conductor	Color	Alternate Color
Ungrounded (Line)	Brown	Black
Grounded (Neutral)	Light Blue	White
Grounded (Earth ground)	Green/Yellow	Green

Table 2-6: Power cord identification

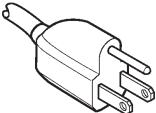
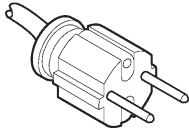
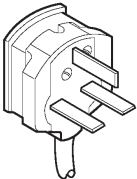
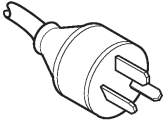
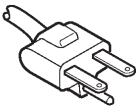
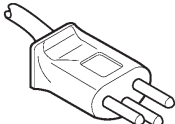
Plug Configuration	Normal Usage	Option Number
	North America 125 V	Standard
	Europe 230 V	A1
	United Kingdom 230 V	A2
	Australia 230 V	A3
	North America 230 V	A4
	Switzerland 230 V	A5

Applying and Interrupting Power

Consider the following information when you power on or power off the instrument, or when external power loss occurs.



CAUTION. You can not power on the instrument when the ambient temperature exceeds the instrument temperature operation range. Wait until the instrument cools down, or the ambient temperature decreases to a valid operating temperatures, before turning on the instrument again.

Power On

The LCD display is blank when the instrument is turned off. Push the front panel switch labeled POWER to power on the instrument. See Figure 2–3.

Make sure that the fan is turning.

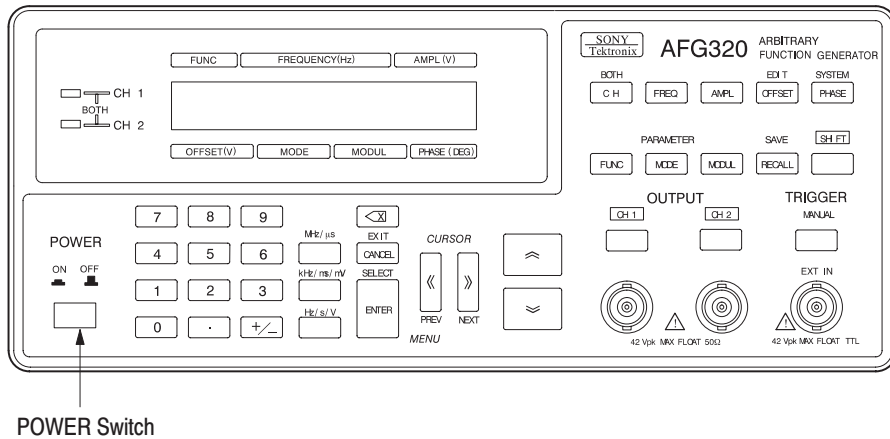

Figure 2-3: POWER switch

Self Test Check the results of the startup self test.

Power-on tests occur automatically each time you power on the instrument.

If an error is detected, an error message is displayed. Refer to Diagnostics on page 6–7 for detail.

Power Off To power off the instrument, press the POWER switch.

NOTE. The instruments current settings are not automatically stored at power off. To store instrument settings for the next power on, use the SAVE menu before powering off.

Repackaging Instructions

If this instrument is shipped by commercial transportation, use the original packaging material. If the original packaging is unfit for use or is not available, repackage the instrument as follows:

1. Obtain a corrugated cardboard shipping carton having inside dimensions at least six inches greater than the instrument dimensions and having a carton test strength of at least 124.74 kg (275 pounds).
2. If the instrument is being shipped to a Tektronix Service Center for repair or calibration, attach a tag to the instrument showing the following: owner of the instrument (with address), the name of a person at your firm who may be contacted if additional information is needed, complete instrument type and serial number, and a description of the service required.
3. Wrap the instrument with polyethylene sheeting or equivalent to protect the outside finish and prevent entry of packing materials into the instrument.
4. Cushion the instrument on all sides by tightly packing dunnage or urethane foam between the carton and the instrument, allowing for three inches of padding on each side (including top and bottom).
5. Seal the carton with shipping tape or with an industrial stapler.

Operating Instructions

This section describes the AFG310 and AFG320 Arbitrary Function Generators menu system and numeric and text input methods.

Before servicing the AFG310 and AFG320 Arbitrary Function Generators, read the following operating instructions. These instructions are at the level appropriate for servicing the AFG310 and AFG320 Arbitrary Function Generators. The user manual contains complete operator instructions.

In addition, the *Performance Verification*, section includes instructions for making the front-panel settings that are required to check the AFG310 and AFG320 Arbitrary Function Generators characteristics.

This section contains the following information:

- Provides an overview of the instrument controls and their functions
- Provides an LCD display example
- Describes basic operating procedures grouped by function
- Explains how to enter numbers
- Explains how to output a waveform
- Explains how to edit, save, and input waveforms
- Describes the terminology and content of representative screen displays
- Provides tutorials covering basic procedures for waveform output and basic settings on the AFG320 Arbitrary Function Generator

Controls and Connectors

Front Panel Figure 2-4 shows the locations of the front-panel controls and connectors.

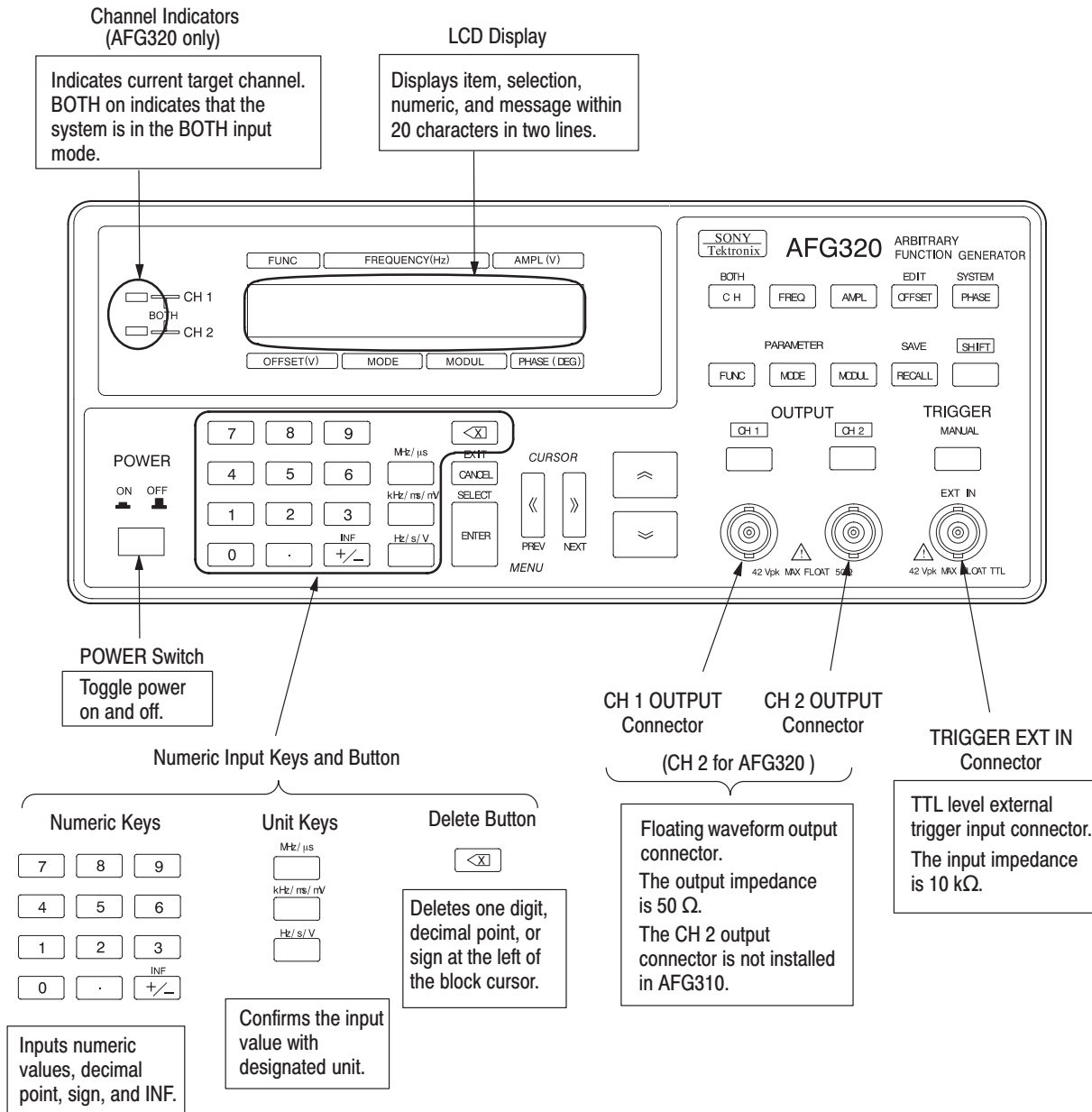

Figure 2-4: Front panel controls

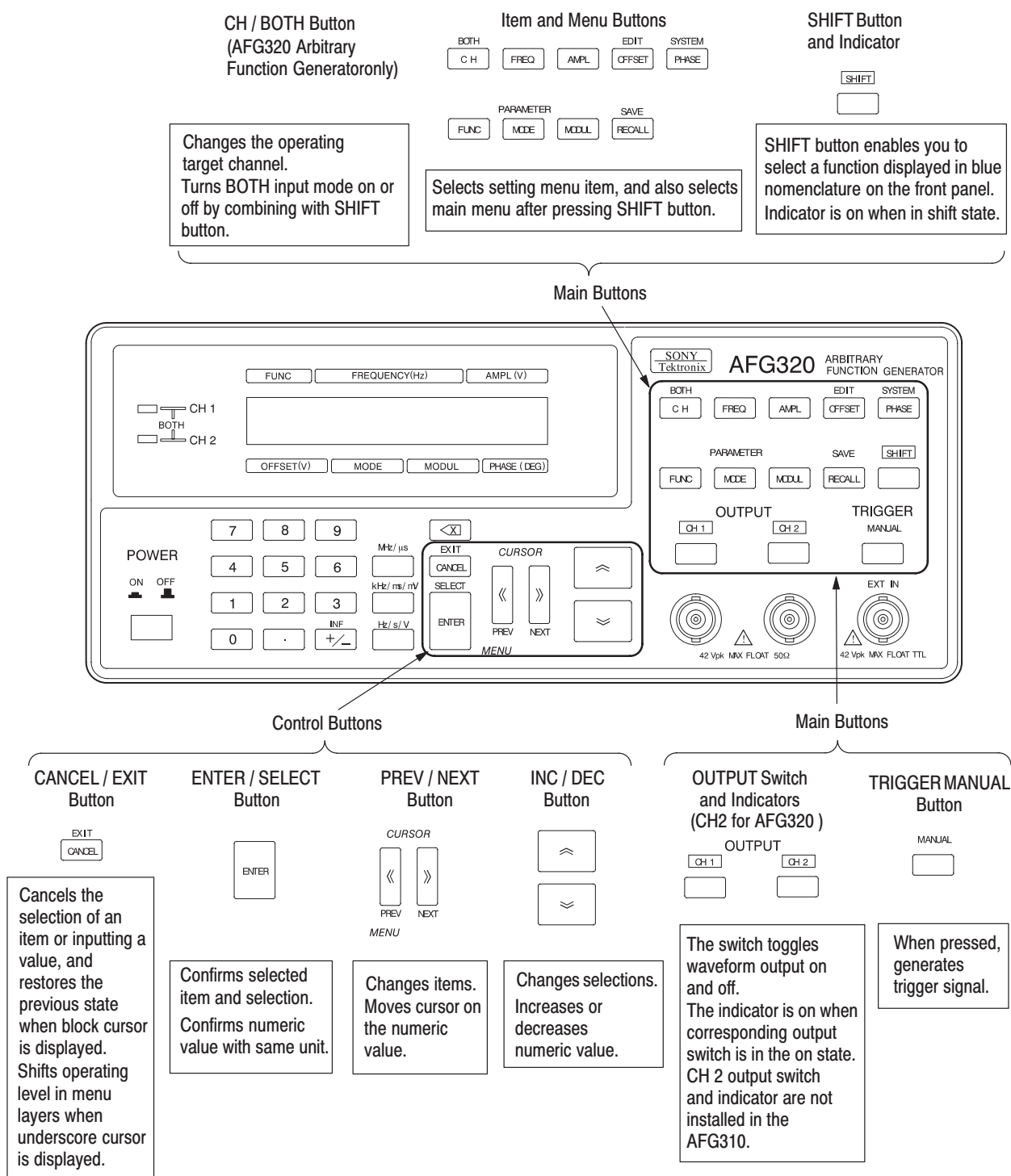

Figure 2-4 (cont.): Front panel controls

Rear Panel Figure 2-5 shows the rear panel controls and connectors.

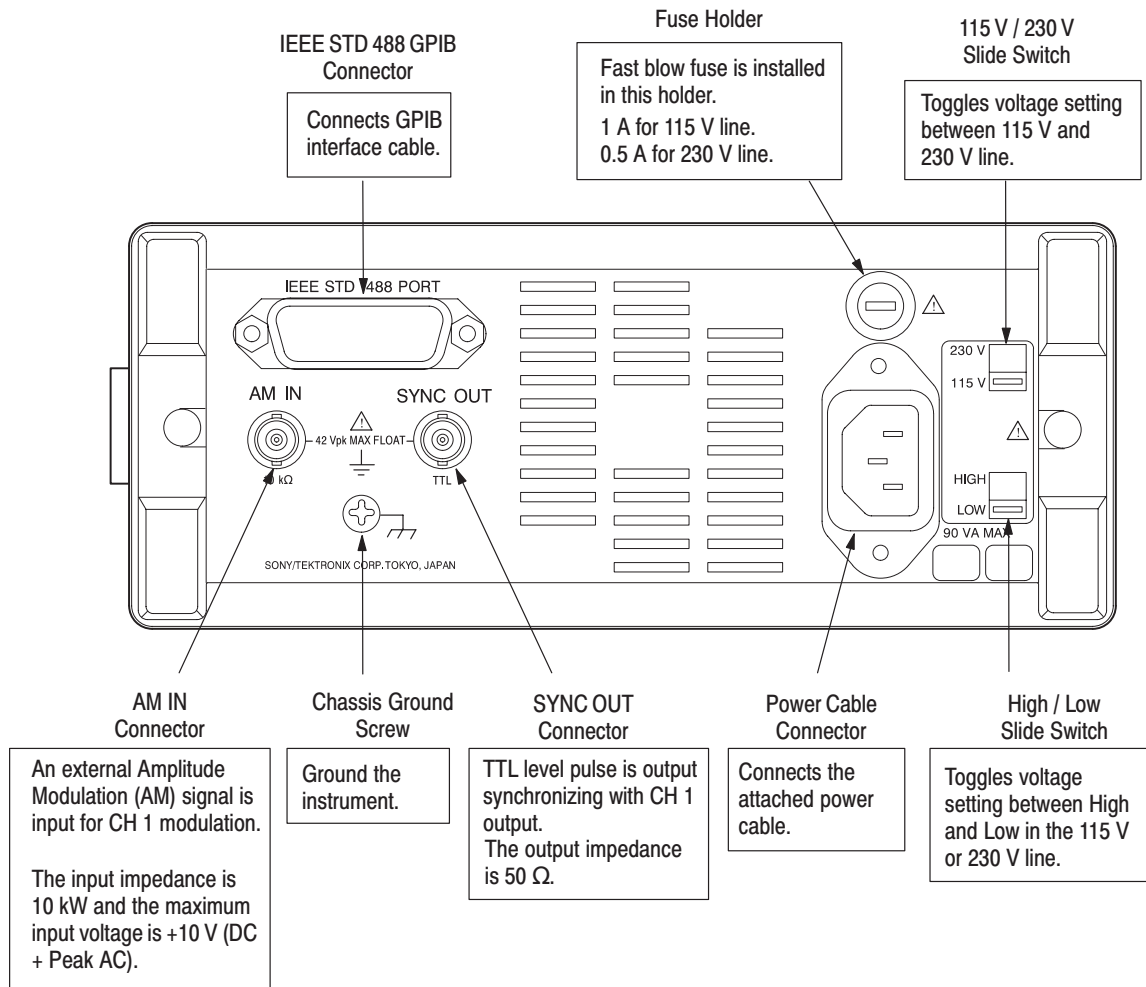

Figure 2-5: Rear panel

Input and Output Connectors

This instrument provides an OUTPUT, SYNC OUT, TRIGGER EXT IN, and AM IN connector. These are floating outputs or floating inputs. The note “42 Vpk MAX FLOAT” appears on the panel adjacent to each of these connectors to indicate that they are floating connections. For examples of floating connections, refer to *Appendix C: Floating Connections* in the AFG310 and AFG320 Arbitrary Function Generators User Manual.



WARNING. To prevent electrical shocks, do not apply voltages in excess of 42 Vpk to any BNC connector ground or to the chassis ground.

All BNC commons must be at the same potential.

OUTPUT Connector. The output connector outputs the waveforms generated by the instrument. The AFG310 Arbitrary Function Generator provides a CH1 connector and the AFG320 Arbitrary Function Generator provides a CH1 and a CH2 connector.

- The output impedance is 50 Ω . The voltage displayed on the LCD is the voltage output when a 50 Ω termination is provided. When the output is open, a voltage twice that is displayed on the LCD from the OUTPUT connector(s).



CAUTION. To prevent damage to the instrument, do not short the output pins or apply external voltages.

SYNC OUT Connector. This connector outputs a TTL level pulse synchronized with the CH1 output. See *Appendix D: SYNC Signal Output* in the AFG310 and AFG320 Arbitrary Function Generators User Manual on page D-1, for details on signal output timing.

The output impedance is 50 Ω .

TRIGGER EXT IN Connector. The EXT IN connector inputs a TTL level external trigger signal.

The input impedance is 10 k Ω .



CAUTION. *To prevent damage to the instrument, do not apply excessive inputs over +5 V.*

AM IN Connector. The AM IN connector inputs an external AM modulation signal. See *AM (AM) Modulation* on page 3–17 in the AFG310 and AFG320 Arbitrary Function Generators User Manual for details on input level and modulation depth.

The input impedance is 10 k Ω .

Basic Menu Operations

This subsection contains the following information:

- Reading an LCD display
- Moving between menus
- Entering Numeric input
- Outputting a waveform
- Setting the waveform parameters
- Setting the operation mode
- Applying modulation/sweep to the output waveform
- Recalling a setting
- Saving setups
- Editing, saving, and importing waveforms
- Setting the instrument system

LCD Display The LCD (liquid crystal display), shows the Default Display or the Menu Item Display. Refer to Figure 2–4 for the location of the LCD Display on the front panel. For an example of the Default Display, refer to Figure 2–6. For an example of the Menu Item Display, refer to Figure 2–7.

Default Display. In this state, the current CH1 values for the setting menu items (FUNC, FREQ, AMPL, OFFSET, MODUL, MODE, and PHASE) are displayed.

The instrument goes to the default display state after power on, after executing the initialization procedure, and after executing the secure operation.

Press the EXIT (CANCEL) button repeatedly to return to the default display from states in which menu items are displayed. Return to the default display by pressing the OFFSET, MODE, MODUL, or PHASE button.

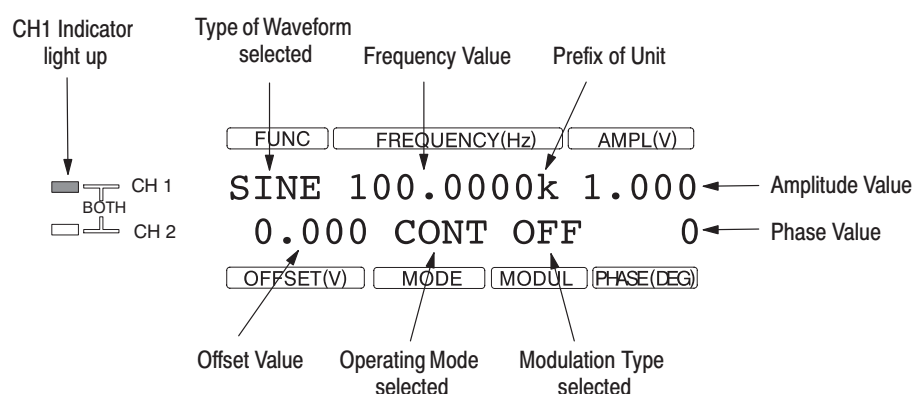

Figure 2–6: Default display

Menu Item Display. When the SHIFT button and then one of the EDIT, SYSTEM, FUNC PARAMETER, MODE PARAMETER, MODUL PARAMETER, or RECALL buttons are pressed sequentially, or when the SAVE button is pressed, the corresponding menu item will be displayed in the second line of the LCD. The display example shown below occurs when the FUNC PARAMETER menu has been selected.

In some cases the FUNC PARAMETER, MODE PARAMETER, or MODUL PARAMETER, shown in the second line of the LCD, is not a valid parameter for the FUNC displayed in the first line of the LCD. For example, the FUNC PARAMETER Pulse Duty has no effect on the FUNC SINE as displayed in Figure 2–7.

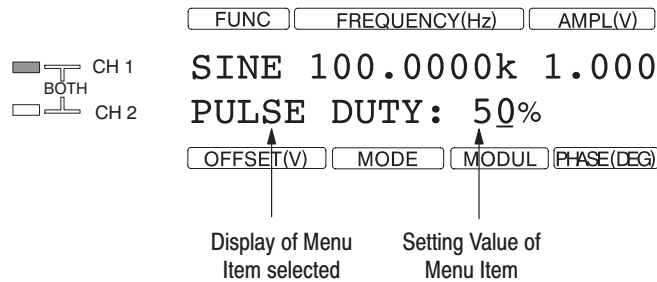

Figure 2-7: Menu item display

Moving Between Menus

The buttons used for selecting main menus and items from the setting menu are located in the upper right section of the front panel. Refer to Figure 2-8.

- Item buttons in the Setting menu (seven items)
FREQ, AMPL, OFFSET, PHASE, FUNC, MODE, MODUL
- Main menu buttons (seven types)
EDIT, SYSTEM, FUNC-PARAMETER, MODE-PARAMETER, MODUL-PARAMETER, RECALL, SAVE

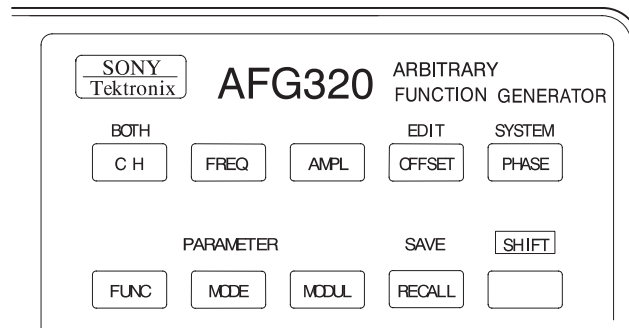

Figure 2-8: Item buttons and main menu buttons

Operation for Setting the Menu Items. Follow the steps below for setting the menu items:

1. Select the desired item using the front panel item buttons.

Depending on the item selected, the underscore cursor will be displayed at either the numeric value or at the selection on the LCD display.

2. Enter the numeric value, or make the selection.
 - Numeric values can be changed with the \wedge and \vee buttons. Alternatively, the value can be entered with the numeric keys and confirmed by pressing a unit key or the ENTER button.
 - Use the \wedge and \vee buttons to change a selection. Confirm the selection with the ENTER button.

Prior to confirmation (when the block cursor is blinking), numeric values and selections can be restored to their original states by pressing the CANCEL button.

Operation for the Main Menus. Follow the steps below for main menu operation:

1. Select the desired menu using the front panel menu buttons.

One of the items included in the selected menu will appear to the left of the colon in the second row on the LCD screen, and one numeric value or selection for that item is displayed to the right of the colon. See Figure 2–9.

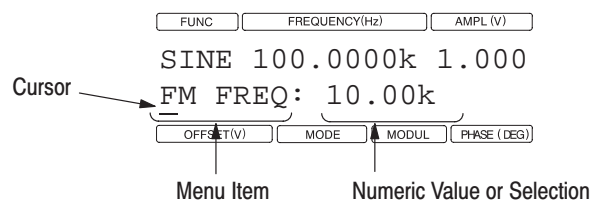

Figure 2–9: Display example for a main menu selected

The underscore cursor will appear either in the item to the left of the colon or in the selection area or a numerical value to the right of the colon. For menus with only one item, the cursor will be displayed immediately at the selection or numeric value.

The procedure from this point will depend on whether the cursor is displayed to the left or right of the colon:

- If the cursor is displayed on the item (to the left of the colon), proceed to Step 2.
- If the cursor is displayed in the selection area or number (to the right of the colon), proceed to Step 3, or press the EXIT (CANCEL) button to go to the item selection level and then proceed to Step 2.

2. Use the < and > buttons to change items until the desired item is displayed. Then confirm the selected item with the ENTER button.

The cursor moves to selection or numeric value to the right of the colon.

3. Enter the numeric value, or make the selection.
 - Numeric values can be changed with the ^ and v buttons. Alternatively, the value can be entered with the numeric keys and confirmed by pressing a unit key or the ENTER button.
 - Use the ^ and v buttons to change a selection. Confirm the selection with the ENTER button.

Prior to confirmation (when the block cursor is blinking), numeric values and selections can be restored to their original states by pressing the CANCEL button.

4. Press the EXIT (CANCEL) button to switch to the higher level (to the item selection level) and to make it possible to repeat Steps 2 through 4.

It is possible to select another menu or set an item at any time while the underscore cursor is displayed. When a menu is selected, the same item and its selection will be displayed with same cursor location as they were the last time that menu was selected.

Each time the EXIT (CANCEL) button is pressed, the system switches to the next higher level, and finally returns to the default display. In addition to the EXIT (CANCEL) button, the OFFSET, PHASE, MODE, and MODUL buttons can also be used to return to the default display.

Numeric Input

An underscore is displayed at one of the digits in the numeric value on the LCD display when numeric input is required. See Figure 2-10.

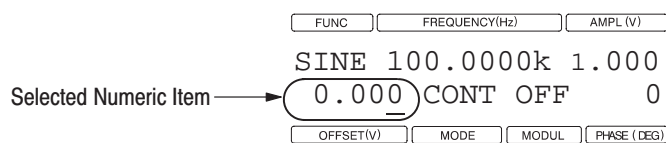

Figure 2-10: Display example for a numeric item selected

The numeric keys and control buttons are used for numeric input.

Using the Numeric Buttons. Follow the steps below to input numeric values.

Use the buttons and keys, shown in Figure 2–11, to input numeric values with the numeric keys.

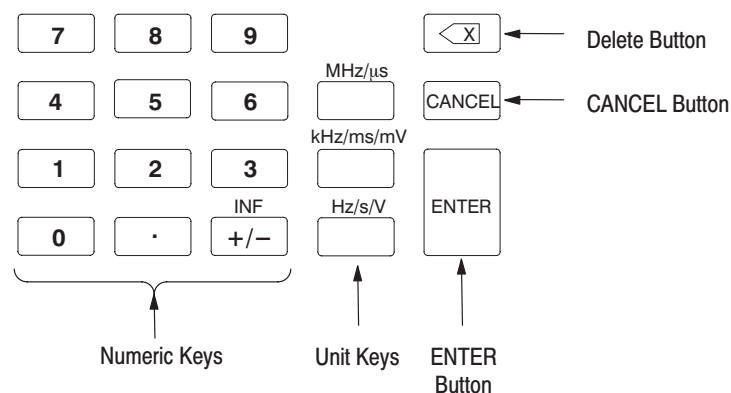

Figure 2–11: Buttons and keys for inputting numeric value

1. Input the target value using the numeric keys.

Figure 2–12 shows the input of the value –1.0. When the numeric keys are used for input, a block cursor is displayed as shown in the figure.

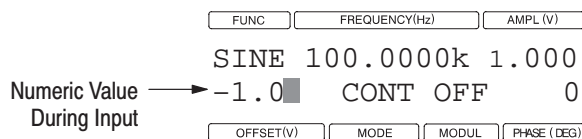

Figure 2–12: Example for inputting numeric value

Use either the delete button or the CANCEL button to correct an input.

- Delete Button. This button deletes one digit, decimal point, or the +/- character to the left of the block cursor. If the delete button is pressed and held down; the delete operation is repeated.
- CANCEL Button. The value input is cancelled, and the original value is displayed.

- The input numeric value is confirmed by pressing a unit key or the ENTER button.

NOTE. The +/- character can be input at any point prior to confirming the numeric value for numeric items that allow a negative value.

If a value outside the valid range for a numeric item is entered, the value will be replaced by the smallest or largest value in that range when the value is confirmed. If a value is entered to greater precision than the resolution of the numeric item, the value will be rounded off when confirmed.

Using the Control Buttons. Follow the steps below to change the numeric value.

Use the buttons shown in Figure 2-13 to change the numeric values.

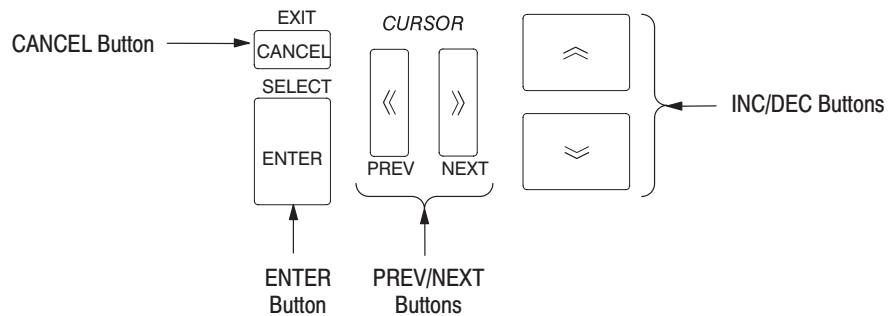

Figure 2-13: Buttons for changing numeric value

- Place the cursor on the digit that will be changed by pressing the < or > button.
- Use the ^ and v buttons to change the numeric value.

Use the CANCEL button to correct an input. Note that this operation is valid when the block cursor is displayed. The CANCEL button cancels the input value and redisplay the original value.

If the cursor is placed on the highest digit and the digit is reduced to 1, the value will not change if the v button is pressed again. At this point the value can be reduced by moving the cursor to the next lower digit. Amplitude and offset values are the exception.

- Amplitude. The value to the left starting at the position of the cursor can be reduced to 1 (in the case of values like 1.030 and 0.120) or 0 (in the case of values like 0.235 and 0.080). Then pressing the v button reduces the value to the minimum value of 0.050.

- Offset. If the current offset value is positive, press the \vee button to reduce the value to the left starting at the position of the cursor to 0. Pressing this button again reduces the value in the minus region. If the current offset value is negative, pressing the \wedge button increases the value across 0 as well.

Phase values can be negative as well. However, to change the value above or below zero, the cursor must be moved temporarily to the least significant digit.

3. After a value has been changed, the value can be confirmed by pressing a unit key or the ENTER button if the block cursor is blinking.

When a value has been changed, some items require that the front panel ENTER button be pressed. If an underscore cursor is displayed after a value has been changed, that item is already confirmed. If the block cursor is blinking after the value has been changed, either a unit key or the ENTER button must be pressed to confirm that value. See Tables 2-7 and 2-8.

When the underscore cursor is displayed, it is not necessary to press the ENTER button.

The numeric values for the **FREQ**, **AMPL**, **OFFSET**, and **PHASE** items in the setting menu have the characteristics of the numeric values in setting Example 1.

Table 2-7: Numeric value input for Example 1

Buttons for input	LCD display	Numeric value status
	1.00	Before input
>	1.00	During input
\vee	0.90	
\vee	0.80	Entered

When the underscore cursor has changed to the block cursor, either a unit key or the ENTER button must be pressed to confirm the value. If a unit key or the ENTER button is not pressed, the value will revert to the previously set value after exiting from the menu.

The numeric values for other than the **FREQ**, **AMPL**, **OFFSET**, and **PHASE** items in the setting menu have the characteristics of the numeric values in setting Example 2.

Table 2-8: Numeric value input for Example 2

Buttons for input	LCD display	Numeric value status
	121.0 k	Before input
<	121.0 k	During input
∨	120.0 k	
<	120.0 k	
∨	110.0 k	
∨	100.0 k	
∨	90.00 k	
ENTER	90.00 k	Entered

Outputting the Waveform

Follow the steps below to output a waveform:

1. Connect an oscilloscope to the function generator to observe the output waveform.
2. Select a target channel for operation.

The settings can be set for each channel independently. Select the desired channel before setting each item.

The CH indicator displays the selected channel. Press the CH button to change the channel.

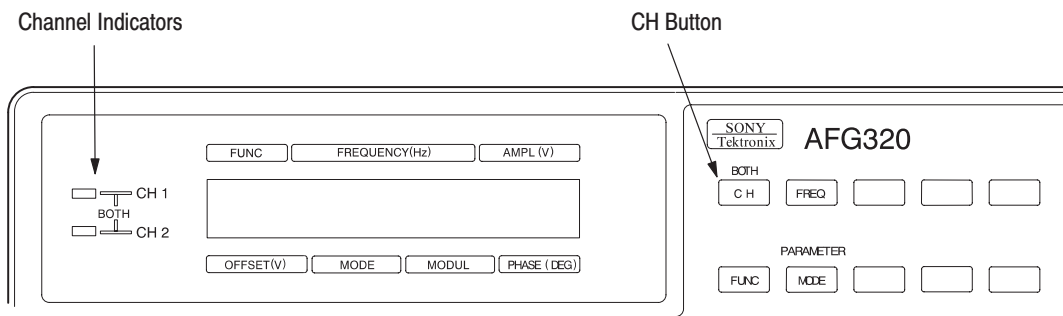

Figure 2-14: CH button and channel indicators

- 3.** Select one of the standard waveforms.
 - a.** Press the FUNC button on the front panel.
 - b.** Use the \wedge and \vee buttons to scroll through the waveform names until the desired standard waveform is displayed in the LCD.
 - c.** Press the ENTER button to confirm the selected waveform.
- 4.** Press the OUTPUT switch to start the waveform output.

The OUTPUT switch opens and closes the line that connects the instruments internal output circuit to the output connector. When this switch is on a waveform corresponding to the currently set output mode (continuous, triggered, or burst mode), will be output from the OUTPUT connector.



Theory of Operation

Theory of Operation

This section describes the electrical operation of the AFG310 and AFG320 Arbitrary Function Generator modules. Refer to Figure 8–1: Block Diagram and Figure 8–2: Interconnect diagram, beginning on page 8–2.

Module Overview

The 42.9MHz clocks are supplied from the crystal oscillator to the Address Decoder & Trig/Clock Control to conduct major control as a function generator together with the main CPU.

The trigger signal from EXT TRIG IN on the front panel is passed through the comparator and then sent to the Address Decoder & Trig/Clock Control circuit. The GPIB controller is also controlled by this circuit.

The Timing & Memory Address Control provided for each channel controls output waveforms. The waveforms from the SYNC Out on the rear panel are generated by the circuit on the CH1 side.

Basic sine waveforms are generated by DDS (Direct Digital Synthesis). DDS uses Sequence Memory, SIN REF, and clock (42.9 MHz) inputs. The DDS output is fed through a 20 MHz elliptical Filter.

Basic square waveforms are generated by sending the output of the 20 MHz elliptical Filter through a SIN/SQ Converter.

All other waveforms are generated by sending the data read from Waveform Memory to the 12-bit D/A through the 5 MHz Elliptical Filter. The Waveform Memory clock is supplied by the SIN/SQ Converter.

When AM modulation is selected for CH1 output waveforms, the original waveform is amplitude-modulated internally by an external signal from the AM IN connector on the rear panel.

Each analog waveform signal is put at the desired output level including an offset by the Analog Output circuit consisting of an amplifier, an attenuator and an offset circuit.

The circuit configuration is the same for CH2 except the AM IN circuit is available for CH1 only.

Front Panel (A10) and LCD

The front-panel switch is read by the PLD (Programmable Logic Device) on the front panel board, and any setting changes are reported to the A20/A30 (MAIN).

Also, the PLD controls LED On/Off and Beeper operation and LCD (20 × 2 rows) indication.

EXT TRIG IN. The trigger signal from EXT TRIG IN on the front panel is passed through the comparator and then sent to the Address Decoder & Trig/Clock Control circuit.

Main (A20)

The main board (A20) is the core of the function generator. It contains major parts of the signal generators including digital circuits (such as CPU, DDS, Waveform memory and D/A) and Analog circuits (such as Filter, output AMP and Offset circuit).

CPU and Address Decoder & Trig/Clock Control. 42.9 MHz clocks are supplied from the crystal oscillator to the Address Decoder & Trig/Clock Control to conduct major control as a function generator together with the CPU.

Analog output circuit. Each analog waveform signal is put at the desired output level including an offset by the Analog Output circuit consisting of an amplifier, an attenuator and an offset circuit.

Timing & Memory Address Control. The Timing & Memory Address Control provided for each channel controls output waveforms. Also, the waveform from the SYNC Out on the rear panel is generated by the circuit on the CH1 side.

Sine waveform generation (DDS). Sine waveform is generated by DDS (Direct Digital Synthesis) from the crystal oscillator's clock (42.9 MHz) according to the data of the Sequence Memory and then is passed through the 20 MHz Elliptical Filter.

Square waveform generation (Sine/Square converter). Square waveform is generated by the Sine/Square converter.

Standard waveform (except sine and square) generation. The Standard waveforms (Triangle, Ramp, Pulse, and Noise) are generated via the 5 MHz Elliptical Filter by sending to the 12-bit D/A the data read from waveform memory. Clock is supplied from the Sine/Square converter.

DC waveform. The DC waveform is generated from the offset circuit.

Arbitrary waveform generation. The Arbitrary waveform is generated via the 5 MHz Elliptical Filter by sending the data read from waveform memory to the 12-bit D/A. Clock is supplied from the Sine/Square converter.

AM modulation. For CH1 output waveforms, when AM modulation is selected, the original waveform is amplitude-modulated internally by an external signal from the AM IN connector on the rear panel.

GPIB. The A20 Board has the General Purpose Interface Bus (GPIB) interface driver, which controls communication with external devices over the parallel interface. The GPIB (IEEE STD 488 PORT) connector is on the rear panel.

CH2 (A30)

The CH2 (A30) is of the same configuration as Main (A20) except the System Processor circuits (CPU and GPIB) and AM modulator.

Channel 2 circuit. The CH2 side of AFG320 is of the same circuit configuration except the above AM IN circuit.

Power Supply (A40) and Transformer

The low-voltage power supply board (A40) supplies +5 V, -5 V, +15 V, and -15 V to all the Analog and Digital circuits, and power to the fan. Also, the main POWER switch (S101) and Line Voltage select switch (S102/S103) are located on this board. The S102/S103 is used to switch the transformer winding to the local AC line voltage.

Fan

The DC fan on the rear panel provide forced air cooling for the Arbitrary Function Generator.

Both AFG310 and AFG320 are portable function generators (AFG310 is a single channel and the AFG320 is a dual channel).

Floating section The function generator is roughly classified into two sections:

Floating section. All the circuits of the generator except the GPIB communication are contained in this section. This includes the AM IN, SYNC IN and EXT TRIG IN connectors.

Earth reference section:

Only the GPIB communication is contained in this section. Control signals such as GPIB and CPU are insulated by optical components.



Performance Verification

Performance Verification

Two types of performance tests can be performed on this product. You may not need to perform all of these procedures, depending on what you want to accomplish.

- To quickly confirm that the the AFG310 or AFG320 Arbitrary Function Generator is operating properly, complete the *Self Test* under *Brief Procedures* that begins on page 4–2.
- To further check functionality and proper calibration, first complete the Self Test; then complete the brief procedures under *Calibration Test* that begins on page 4–3.

Advantages: These procedures are quick to do, require no external equipment or signal sources, and perform extensive functional and accuracy testing to provide high confidence that the Arbitrary Function Generator will perform properly. They can be used as a quick check before making a series of important measurements.

If you are not familiar with operating this Arbitrary Function Generator, read the *Getting Started* and *Operating Basics* sections in this manual. These sections contain instructions that will familiarize you with the use of the front panel controls and the menu system.

Conventions

Throughout these procedures the following conventions apply:

- Each test procedure uses the following general format:
 - Title of Test
 - Equipment Required
 - Prerequisites
 - Procedure
- Each procedure consists of as many steps and substeps as required to do the test. Steps and substeps are sequenced. Refer to *Conventions* on page xii for further information.

Brief Procedures

Follow the *Self Test* and *Calibration Test* procedures below to verify that the AFG310 or AFG320 is operating properly.

Self Test This procedure uses internal routines to verify that the Arbitrary Function Generator is operating properly. No test equipment or hookups are required.

Table 4-1: Self Test Requirements

Equipment Required	Prerequisites
None	Power on the Arbitrary Function Generator and allow a 20 minute warm up before doing this procedure.

Do the following steps to verify passing of internal self test.

1. Select the **SELF TEST** item in the **SYSTEM** menu. Do the following procedure:
SHIFT → PHASE → < button until SELF TEST is displayed → ENTER
2. Press **ENTER** button to execute self test.
The message “***TESTING***” is displayed in the first line of the LCD during self test.
3. Wait until the test is completed.

When an error is detected during diagnostic execution, the instrument displays the name of that test item.

If multiple errors were detected, the test item names can be viewed using the **∨** and **∧** buttons.

Press the front panel **EXIT/CANCEL** button to exit from the error display state.
4. Verify passing of the internal self test.

If the self test completes without finding any problems, the display returns to its state before the self test was executed.
5. Return to regular service. Press **EXIT/CANCEL** button until the default display is obtained.

Calibration Test This procedure uses internal routines to verify proper calibration. No test equipment or hookups are required.

Table 4-2: Calibration Test Requirements

Equipment Required	Prerequisites
None	Power on the Arbitrary Function Generator and allow a 20 minute warm up before doing this procedure. An ambient temperature is between +20° C and +30° C.

Do the following steps to verify passing of internal calibration.

1. Select the **CALIBRATION** item in the **SYSTEM** menu. Do the following procedure:

SHIFT → PHASE → < button until **CALIBRATION** is displayed → ENTER

2. Press ENTER button to execute calibration.

The message “***CALIBRATING***” is displayed in the first line of the LCD during calibration.

NOTE. Do not turn off the power while “***CALIBRATING***” is displayed. If the power is turned off while the message is displayed, data stored in internal nonvolatile memory may be lost.

3. Wait until the calibration is completed.

When an error is detected during calibration execution, the instrument displays the name of that calibration item.

If multiple errors were detected, the calibration item names can be viewed using the ∨ and ∧ buttons.

Press the front panel **EXIT/CANCEL** button to exit from the error display state.

4. Verify passing of the internal calibration.

If the calibration completes without finding any problems, the display returns to its state before the calibration was executed.

5. Return to regular service. Press **EXIT/CANCEL** button until the default display is obtained.

Performance Tests

This section contains the following procedures for checking that the Arbitrary Function Generator performs as warranted:

- Output Waveform Checks
- Frequency Accuracy Checks
- Amplitude Accuracy Checks
- DC Voltage Accuracy Checks
- Operating Mode and Phase Checks
- Modulation Checks

Prerequisites

The tests in this subsection do an extensive check of performance and functionality when the following requirements are met:

- The cabinet covers must be on the Arbitrary Function Generator.
- You must have performed and passed the procedures under Self Tests and Calibration, on page 4–2.
- The Arbitrary Function Generator must have been calibrated at an ambient temperature between +20° C and +30° C, must have been operating for a warm-up period of at least 20 minutes, and must be operating at an ambient temperature between 0° C and +50° C.

Equipment Required The following equipment is required to check the performance of the Arbitrary Function Generator.

Table 4-3: Test Equipment

Item Number and Description	Minimum Requirements	Example	Purpose
1 Terminator, 50 Ω	Impedance 50 Ω ; connectors: female BNC input, male BNC output; 50 Ω +/- 1 Ω , 2 W, DC to 1 GHz	Tektronix part number 011-0049-01	Signal Termination for many Test
2 Terminator, 50 Ω , Precision	Impedance 50 Ω ; connectors: female BNC input, male BNC output 50 Ω +/- 0.05 Ω , 2 W, DC to 100 kHz	Tektronix part number 011-0129-00	Checking DC Offset and Amplitude
3 Cable, 50 Ω Coaxial (three required)	50 Ω , 43 in, male to male BNC connectors	Tektronix part number 012-0057-01	Signal Interconnection
4 Connector, BNC "T"	Male BNC to dual female BNC	Tektronix part number 103-0030-00	Checking Operating Mode and Phase
5 N-to-BNC adapter	1		Tektronix part no. 103-0045-00
6 Connector, Dual-Banana	Female BNC to dual banana	Tektronix part number 103-0090-00	Various Accuracy Tests
7 Digital Oscilloscope	Over 100 MHz BW	Tektronix TDS	Checking output signals
8 Frequency Counter/Timer	Frequency Range: 1 Hz to 100 MHz Accuracy: $\pm 5 \times 10^{-5}$	Anritsu MF1603A	Checking Frequency Accuracy
9 Signal Generator	Output Range: 0 V to 5 V Frequency: 10 kHz	Tektronix CFG253	Checking Operating Mode and Phase
10 Digital Multimeter	Voltage Range: 0.05 V to 5 V	Fluke 8842A	Checking Amplitude and Offset Accuracy

Output Waveform Test

Check that the seven types of standard waveforms are output. Refer to Table 4-4 for test requirements.

Table 4-4: Output Waveform Test Requirements

Equipment Required	Prerequisites
One 50 Ω terminator (Item 1 on page 4-5)	The Arbitrary Function Generator must meet the prerequisites listed on page 4-4
One coaxial cable (Item 3 on page 4-5)	
One digital oscilloscope (Item 7 page 4-5)	

1. Connect the function generator to a digital oscilloscope.

Use a 50 Ω coaxial cable to connect to the CH1 output of the function generator to a 50 Ω terminator on the CH1 input of the digitizing oscilloscope. Refer to Figure 4-1.

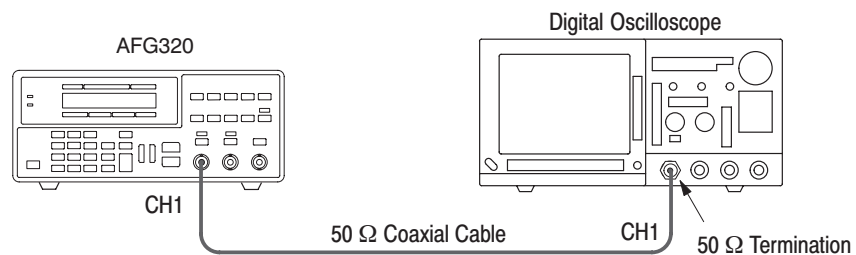

Figure 4-1: Initial Test Hookup

- Set the oscilloscope controls by selecting the function and settings in Table 4–5.

Table 4–5: Oscilloscope settings

Function	Setting
CH 1 Vertical	
Coupling	DC
Scale	0.2V/DIV
Input Impedance	1 M Ω
Horizontal	
Sweep	10 μ s/DIV
Trigger	
Source	CH 1
Coupling	DC
Slope	Positive
Level	+500 mV
Mode	Auto

- Select INITIALIZE in the SYSTEM menu on the function generator. Press the front panel buttons in the following order:
 SHIFT → PHASE → < button until INITIALIZE is displayed → ENTER → ENTER
- Set the CH1 and CH2 frequencies to 20 kHz then set the controls of the function generator to FUNC for both CH1 and CH2.

Press the front panel buttons in the following order:

FREQ → 2 → 0 → kHz/ms/mV

CH → FREQ → 2 → 0 → kHz/ms/mV

FUNC → CH → FUNC

5. Press the CH1 OUTPUT to set the waveform output to on.

NOTE. To change the waveform on the function generator, place the cursor on the name of the waveform in the FUNC item and press the ^ button. When the name of the desired waveform appears, press the ENTER button to confirm the selection.

6. Change the waveform in the FUNC column on the LCD display.
7. Check the output waveform listed in the Table 4–6.

Table 4–6: AFG320 Output Waveform

LCD Display in FUNC Column	Output Waveform Description
SINE	2 Cycles in 10 divisions, Continuous Sine wave
SQUA	2 Cycles in 10 divisions, Continuous Square wave
TRIA	2 Cycles in 10 divisions, Continuous Triangle wave
RAMP	2 Cycles in 10 divisions, Continuous Ramp wave
PULSE	2 Cycles in 10 divisions, Continuous Pulse wave with 50 % duty ratio

- a. Change the duty ratio of Pulse wave for 75 %.

SHIFT → FUNC → 7 → 5 → ENTER

PULSE	2 Cycles in 10 divisions, Continuous Pulse wave with 75 % duty ratio
-------	--

- b. Select the DC waveform and then change the DC offset to 0.5 V.

FUNC → ^ → ENTER → OFFSET → 0 → . → 5 → Hz/s/V

DC	+0.5 V DC
----	-----------

- c. Change the DC offset back to 0 V and then select the noise waveform.

0 → Hz/s/V → FUNC → ^ → ENTER

NOISE	Continuous Noise wave
-------	-----------------------

8. Follow the steps below to check the function generator output waveforms:
 - a. Remove the BNC cable from CH1 connector on the front panel and connect it to the CH2 connector.
 - b. Press the CH2 button to set waveform output to on.
 - c. Press the CH button to change the target channel to CH2.
 - d. Check the CH2 output waveform using the same procedure described in the note on page 4–5.

Frequency Accuracy Test

Check the frequency accuracy of the output waveform. Refer to Table 4–7 for test requirements.

Table 4-7: Frequency Accuracy Test Requirements

Equipment Required	Prerequisites
One coaxial cable (Item 3 page 4-5)	The Arbitrary Function Generator must meet the prerequisites listed on page 4-4
One N-to-BNC adapter (Item 5 page 4-5)	
One frequency counter (Item 8 page 4-5)	

1. Connect the function generator to the Frequency Counter.

Use a 50 Ω coaxial cable to connect the CH1 output of the function generator to the CH1 input of the Frequency Counter. Refer to Figure 4–2.

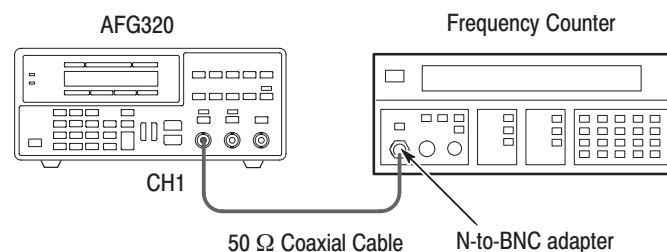

Figure 4-2: Initial Test Hookup

2. Select INITIALIZE in the SYSTEM menu on the function generator. Press the buttons on the front panel in the following order:
 SHIFT → PHASE → < button until INITIALIZE is displayed → ENTER → ENTER

3. Set the CH1 and CH2 frequencies to 16 MHz then press the CH button to change the target channel back to Ch1.

Press the buttons on the front panel in the following order:

FREQ → 1 → 6 → MHz/μs

CH → FREQ → 1 → 6 → MHz/μs → CH

4. Press the CH1 button to set waveform output to on.
5. Check the frequencies or periods listed in the tables below.
 - a. Use the numeric keys and unit keys to change the frequency of the function generator.

LCD Display in FREQ Column	Frequency Range
16.000 00 (MHz)	16.000 800 MHz ~ 15.999 200 MHz
100.000 0 (kHz)	100.005 0 kHz ~ 99.995 0 kHz

- b. Change the measurement mode of the frequency counter to counter timer and check the period.

LCD Display in FREQ Column	Frequency Range
1.000 00 (kHz)	1.000 050 ms ~ 0.999 950 ms
1.000 00 (Hz)	1.000 050 s ~ 0.999 950 s

6. Follow the steps below to check the CH2 frequency accuracy.
 - a. Remove the BNC cable from the CH1 connector on the front panel and connect it to the CH2 connector.
 - b. Press the CH2 button to set waveform output to on.
 - c. Press the CH button on the front panel to change the target channel to CH2.
 - d. Check the CH2 output frequency accuracy using the same procedure described above in Step 5.

Amplitude Accuracy Test

Check the amplitude accuracy of the output waveform. Refer to Table 4–8 for test requirements.

Table 4–8: Amplitude Accuracy Test Requirements

Equipment Required	Prerequisites
One 50 Ω precision terminator (Item 2 on page 4–5)	The Arbitrary Function Generator must meet the prerequisites listed on page 4–4
One coaxial cable (Item 3 page 4–5)	
One dual-banana connector (Item 6 page 4–5)	
One digital multimeter (Item 10 page 4–5)	

1. Use a 50 Ω coaxial cable to connect the CH1 output of the function generator to a 50 Ω precision terminator on the input of the digital multimeter (DMM). Refer to Figure 4–3.

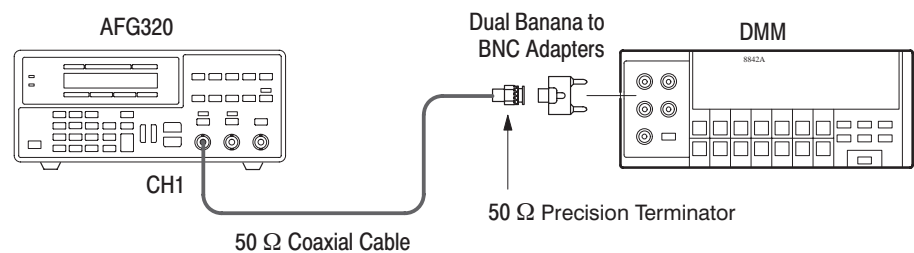
**Figure 4–3: Initial Test Hookup**

2. Set the DMM measurement range to AC 20 V.
3. Select INITIALIZE in the SYSTEM menu on the function generator to initialize the system. Press the buttons on the front panel in the following order:

SHIFT → PHASE → < button until INITIALIZE is displayed → ENTER
→ ENTER

4. Set the CH1 and CH2 frequencies to 1 kHz and amplitude to 10 V_{p-p} then press the CH button to change the target channel back to CH1.

FREQ → 1 → kHz/ms/mV

AMPL → 1 → 0 → Hz/s/V

CH → FREQ → 1 → kHz/ms/mV

AMPL → 1 → 0 → Hz/s/V → CH

5. Press the CH1 button to set the waveform output to on.
6. Check that the amplitude for the sine waveform is within the range listed in the following tables.

Use the numeric keys and unit keys to change the amplitude of the function generator.

LCD Display in AMPL Column	Amplitude Range
10.00 (V _{p-p})	3.572 Vrms ~ 3.499 Vrms
7.000 (V _{p-p})	2.501 Vrms ~ 2.449 Vrms

- a. Set the range of the digital multimeter to AC 2 V.

LCD Display in AMPL Column	Amplitude Range
5.000 (V _{p-p})	1.787 Vrms ~ 1.749 Vrms
3.500(V _{p-p})	1.251 Vrms ~ 1.224 Vrms
2.500(V _{p-p})	0.8944 Vrms ~ 0.8733 Vrms
1.750(V _{p-p})	0.6266 Vrms ~ 0.6108 Vrms
1.000 (V _{p-p})	0.3588 Vrms ~ 0.3483 Vrms
0.700(V _{p-p})	0.2517 Vrms ~ 0.2433 Vrms

- b. Set the range of the digital multimeter to AC 200 mV

LCD Display in AMPL Column	Amplitude Range
0.500 (V _{p-p})	0.1803 Vrms ~ 0.1733 Vrms
0.350 (V _{p-p})	0.1267 Vrms ~ 0.1208 Vrms
0.250 (V _{p-p})	0.09104 Vrms ~ 0.08547 Vrms
0.125 (V _{p-p})	0.04640 Vrms ~ 0.04199 Vrms
0.100 (V _{p-p})	0.03747 Vrms ~ 0.03324 Vrms
0.050 (V _{p-p})	0.01962 Vrms ~ 0.01574 Vrms

7. Change the output waveform to SQUA (square). Set the controls of the function generator to AMPL item.

Press the buttons on the front panel in the following order:

FUNC → ^ → ENTER → AMPL

8. Check that the amplitude for the square waveform is within the range listed in following tables.

Use the numeric keys and unit keys to change the amplitude of the function generator.

LCD Display in AMPL Column	Amplitude Range
0.050 (V _{p-p})	0.02775 Vrms ~ 0.02225 Vrms
0.100 (V _{p-p})	0.05300 Vrms ~ 0.04700 Vrms
0.125 (V _{p-p})	0.06452 Vrms ~ 0.05938 Vrms
0.250 (V _{p-p})	0.12875 Vrms ~ 0.12125 Vrms
0.350 (V _{p-p})	0.17925 Vrms ~ 0.17075 Vrms

- a. Set the range of the digital multimeter to AC 2V and check that the square waveform is within the range listed in following table.

LCD Display in AMPL Column	Amplitude Range
0.500 (V _{p-p})	0.2550 Vrms ~ 0.2450 Vrms
0.700 (V _{p-p})	0.3560 Vrms ~ 0.3440 Vrms
1.000 (V _{p-p})	0.5075 Vrms ~ 0.4925 Vrms
1.750 (V _{p-p})	0.8862 Vrms ~ 0.8638 Vrms
2.500 (V _{p-p})	1.265 Vrms ~ 1.235 Vrms
3.500 (V _{p-p})	1.770 Vrms ~ 1.730 Vrms

- b. Set the range of the digital multimeter to AC 20 V and check that the square wave table is within the range listed in following table.

LCD Display in AMPL Column	Amplitude Range
5.000 (V _{p-p})	2.527 Vrms ~ 2.473 Vrms
7.000 (V _{p-p})	3.537 Vrms ~ 3.463 Vrms
10.00 (V _{p-p})	5.055 Vrms ~ 4.948 Vrms

9. Change the output waveform to TRIA (triangle). Set the controls of the function generator to AMPL item.

Press the buttons on the front panel in the following order:

FUNC → ^ → ENTER → AMPL

10. Check that the amplitude for the triangle waveform is within the range listed in the tables below.

Use the numeric keys and unit keys to change the amplitude of the function generator.

LCD Display in AMPL Column	Amplitude Range
10.00 (V _{p-p})	2.917 Vrms ~ 2.857 Vrms
7.000 (V _{p-p})	2.042 Vrms ~ 1.999 Vrms

- a. Set the range of the digital multimeter to AC 2 V.

LCD Display in AMPL Column	Amplitude Range
5.000 (V _{p-p})	1.459 Vrms ~ 1.429 Vrms
3.500 (V _{p-p})	1.021 Vrms ~ 0.9988 Vrms
2.500 (V _{p-p})	0.7303 Vrms ~ 0.7131 Vrms
1.750 (V _{p-p})	0.5116 Vrms ~ 0.4987 Vrms
1.000 (V _{p-p})	0.2930 Vrms ~ 0.2844 Vrms
0.700 (V _{p-p})	0.2055 Vrms ~ 0.1986 Vrms

- b. Set the range of the digital multimeter to AC 200 mV.

LCD Display in AMPL Column	Amplitude Range
0.500 (V _{p-p})	0.1472 Vrms ~ 0.1415 Vrms
0.350 (V _{p-p})	0.1034 Vrms ~ 0.09859 Vrms
0.250 (V _{p-p})	0.07433 Vrms ~ 0.07001 Vrms
0.125 (V _{p-p})	0.03788 Vrms ~ 0.03428 Vrms
0.100 (V _{p-p})	0.03059 Vrms ~ 0.02714 Vrms
0.050 (V _{p-p})	0.01602 Vrms ~ 0.01285 Vrms

Follow the steps below to check the CH2 amplitude accuracy.

1. Remove the BNC cable from CH1 connector on the front panel and connect it to the CH2 connector.
2. Press the CH2 to set the waveform output to on.
3. Press the CH button to change the target channel to CH2.
4. Check the CH2 output amplitude accuracy using the same procedure described in Steps 6 through 10 on page 4–12.

DC Voltage Accuracy Test

Check the DC voltage accuracy of the offset output.

Use a 50 Ω coaxial cable to connect the CH1 output of the function generator to a 50 Ω precision terminator on the input of the digital multimeter. Refer to Figure 4-3.

Table 4-9: DC Voltage Accuracy Test Requirements

Equipment Required	Prerequisites
One 50 Ω precision terminator (Item 2 on page 4-5)	The Arbitrary Function Generator must meet the prerequisites listed on page 4-4
One coaxial cable (Item 3 page 4-5)	
One dual-banana connector (Item 6 page 4-5)	
One digital multimeter (Item 10 page 4-5)	

1. Set the DMM measurement range to DC 20 V.
2. Select INITIALIZE in the SYSTEM menu on the function generator to initialize the system. Press the buttons on the front panel in the following order:
 - SHIFT → PHASE → < button until INITIALIZE is displayed → ENTER → ENTER
3. Set the CH1 and CH2 FUNC waveforms to DC and offset to +5 V then press the CH button to change the target channel back to CH1.
 - FUNC → ^ button until DC is displayed → ENTER
 - OFFSET → 5 → Hz/s/V
 - CH → FUNC → ^ button until DC is displayed → ENTER
 - OFFSET → 5 → Hz/s/V → CH
4. Press the CH1 button to set waveform output to on.

5. Check that the offset voltage for the DC waveform is within the range listed in the table below.
- Use the numeric keys and unit keys to change the offset of the function generator.
 - Set the range of the digital multimeter to DC 20 V.

LCD Display in AMPL Column	Amplitude Range
5.000 (V)	5.055 V ~ 4.945 V

- Set the range of the digital multimeter to DC 2 V.

1.000 (V)	1.015 V ~ 0.985 V
0.500 (V)	0.510 V ~ 0.490 V

- Set the range of the digital multimeter to DC 200 mV.

0.100 (V)	0.106 V ~ 0.094 V
0.000 (V)	0.005 V ~ -0.005 V
-0.100 (V)	-0.106 V ~ -0.094 V

- Set the range of the digital multimeter to DC 2 V.

-0.500 (V)	-0.510 V ~ -0.490 V
-1.000 (V)	-1.015 V ~ -0.985 V

- Set the range of the digital multimeter to DC 20 V.

-5.000 (V)	-5.055 V ~ -4.945 V
------------	---------------------

6. Check the CH2 DC voltage accuracy by following the steps below:
 - a. Remove the BNC cable from the CH1 connector on the front panel and connect it to the CH2 connector.
 - b. Press the CH2 button above the BNC connector to set the waveform output to on.
 - c. Press the CH button on the front panel to change the target channel to CH2.
 - d. Check the CH2 output DC voltage accuracy using the same procedure described in step 5 on page 4–17.

Operating Mode and Phase Test

Check the phase of the output waveform in the triggered and burst mode.

Refer to Table 4–10 and Figure 4–4 for test requirements and connections.

Follow the steps below to make the proper connections:

1. Use a 50 Ω coaxial cable to connect the CH1 output of function generator to a 50 Ω terminator on the CH1 input of the digital oscilloscope. See Figure 4–4.
2. Use a 50 Ω coaxial cable to connect the output of the signal generator to one side of a BNC T connector.
3. Use a 50 Ω coaxial cable to connect the CH2 input of the digital oscilloscope to the other side of the BNC T connector.
4. Connect the BNC T connector to the EXT TRIG IN connector of function generator.

Refer to Table 4–10 for the accuracy test requirements.

Table 4-10: Operating Mode and Phase Test Requirements

Equipment Required	Prerequisites
One 50 Ω terminator (Item 1 on page 4-5)	The Arbitrary Function Generator must meet the prerequisites listed on page 4-4
BNC "T" connector (Item 4 page 4-5)	
Three coaxial cables (Item 3 page 4-5)	
One signal generator (Item 9 page 4-5)	
One digital oscilloscope (item 10 page 4-5)	

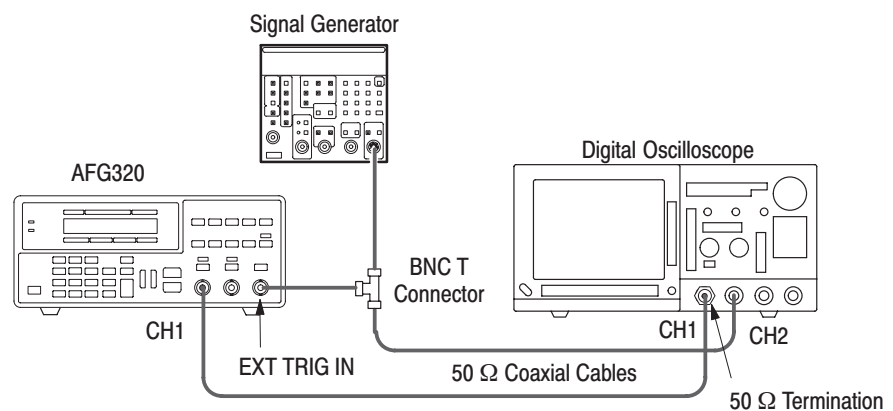
**Figure 4-4: Initial Test Hookup**

5. Refer to Table 4-11 to set the oscilloscope controls.

Table 4-11: Oscilloscope settings

Function	Setting
CH 1 Vertical	
Coupling	DC
Scale	0.2V/DIV
Input Impedance	1 M Ω
CH 2 Vertical	
Coupling	DC

Table 4-11: Oscilloscope settings (Cont.)

Function	Setting
Scale	0.5 V/DIV
Input Impedance	1 M Ω (or external termination if required by source)
Horizontal	
Sweep	20 μ s (adjust for best display)
Trigger	
Source	CH 2
Coupling	DC
Slope	Positive
Level	+500 mV
Mode	Auto

6. Refer to Table 4-12 to set the signal generator controls.

Table 4-12: Signal generator settings

Function	Setting
Frequency	10 kHz (square wave)
Amplitude	0 - 5 V (TTL compatible output)

7. Select INITIALIZE in the SYSTEM menu on the function generator to initialize the system. Press the buttons on the front panel in the following order:

SHIFT → PHASE → < button until INITIALIZE is displayed → ENTER
→ ENTER

8. Set the CH1 and CH2 burst count to 3 and set the operating mode to TRIG (triggered). Press the CH button to change the target channel back to CH1.

SHIFT → MODE → 3 → ENTER

MODE → ^ → ENTER

CH → SHIFT → MODE → 3 → ENTER

MODE → ^ → ENTER → CH

9. Press the CH1 button above the BNC connector to set the waveform output to on.

10. Check that the one cycle of the sine wave is output with the phase according to the phase changing from $+360^\circ$ to -360° in 90° steps. The phase shift is observed at the starting point of the waveform.

Press the following buttons or keys on the front panel to change the phase by -90° (relative value).

PHASE → +/- → 9 → 0 → ENTER

The following Figures are examples of waveforms for the different phase settings.

These screen shots were made with a TDS 700 series oscilloscope with CH 1 set to 200 mV/DIV, and using a TTL compatible (0 – 5 V) 10 kHz square wave for the external trigger source.



Figure 4-5: 1 cycle, $\pm 180^\circ$ phase

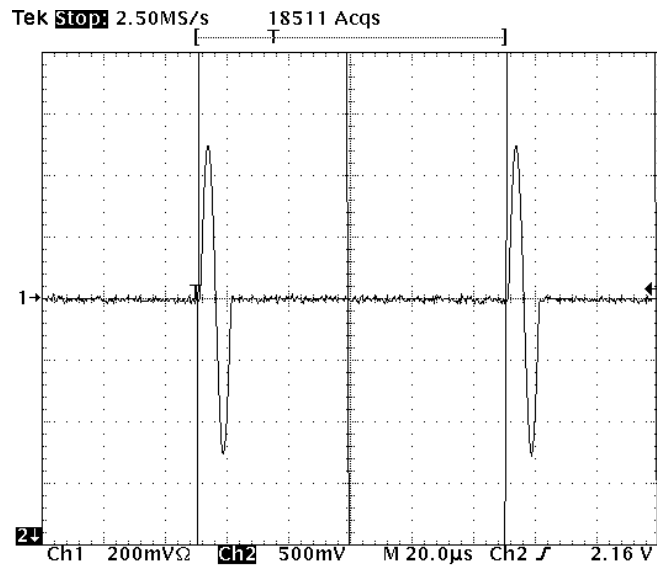

Figure 4-6: 1 cycle, 0° phase ($\pm 360^\circ$)

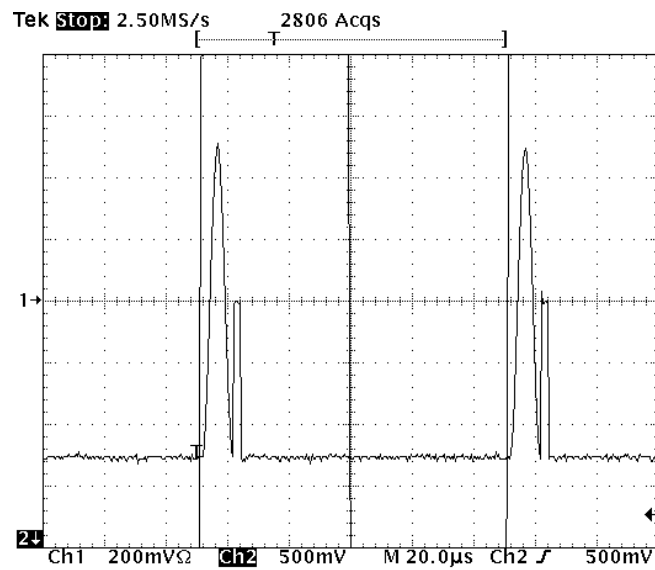

Figure 4-7: 1 cycle, +270° phase (-90°)

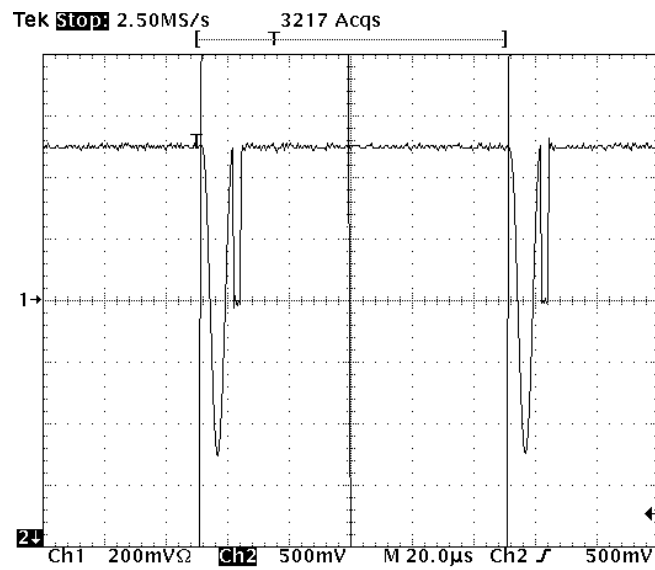

Figure 4-8: 1 cycle, +90° phase (-270°)

11. Follow the steps below to change the operating mode to burst.
Press the following buttons on the front panel to change the mode.

MODE → ^ → ENTER

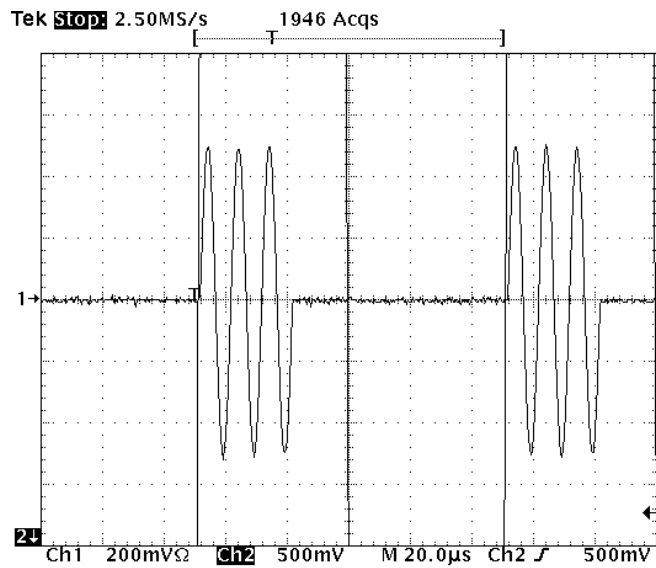

Figure 4-9: 3 cycle, 0° phase (± 360)

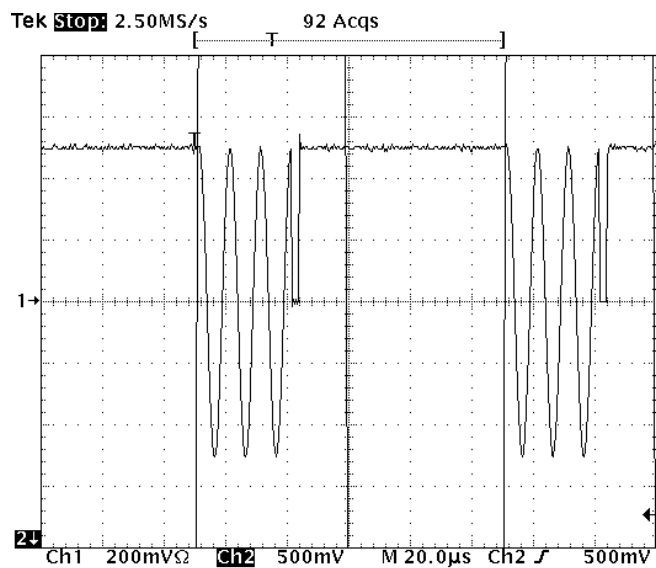

Figure 4-10: 3 cycle, +90° phase (-270)

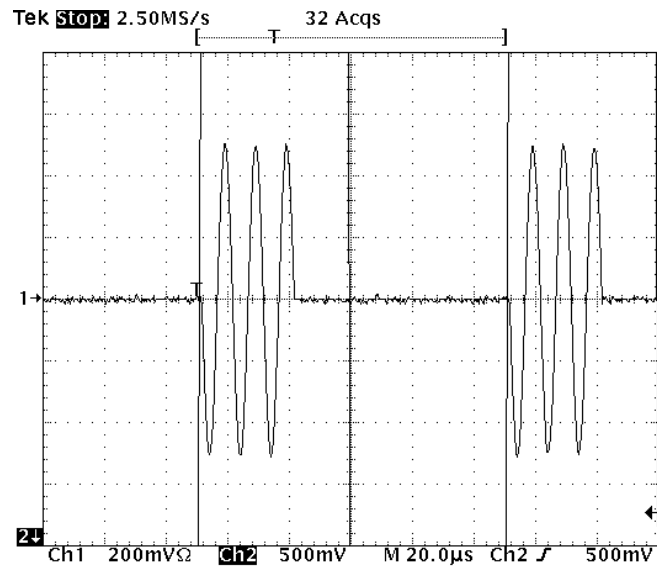

Figure 4-11: 3 cycle, +180° phase (-180)

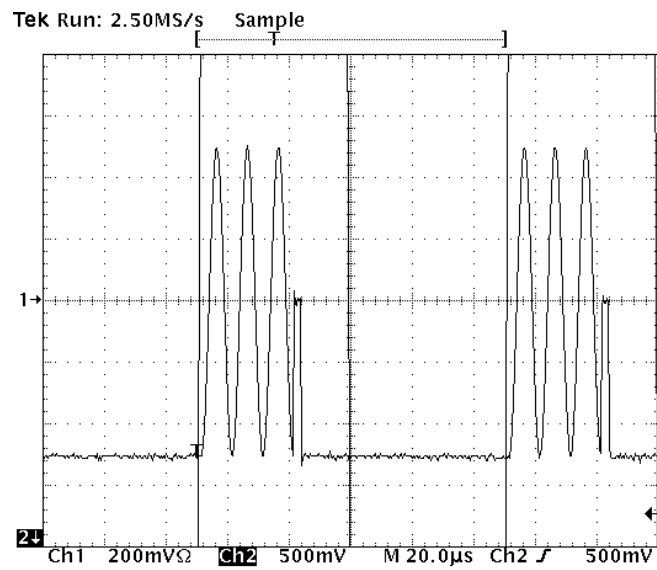

Figure 4-12: 3 cycle, +270° phase (-90)

12. Check that the three cycles of the sine wave is output with the phase according to the phase changing from $+360^\circ$ to -360° in 90° steps.
13. Follow the steps below to check the phase of the CH2 output.
 - a. Remove the BNC cable from the CH1 connector on the front panel and connect it to the CH2 connector.
 - b. Press the CH2 button above the BNC connector to set the waveform output to on.
 - c. Press the CH button on the front panel to change the target channel to CH2.
 - d. Check the phase of the CH2 output using the same procedure described in Step 10 to 12.

Modulation Function Test

Check that the sweep, FM modulation, FSK modulation and AM modulation are functioning. Refer to Table 4–13.

Table 4–13: Modulation Function Test Requirements

Equipment Required	Prerequisites
One 50 Ω terminator (Item 1 on page 4–5)	The Arbitrary Function Generator must meet the prerequisites listed on page 4–4
One coaxial cable (Item 3 page 4–5)	
One digital oscilloscope (item 7 page 4–5)	

14. Connect the function generator to a digital oscilloscope.

Use a 50 Ω coaxial cable to connect the CH1 output of the function generator to a 50 Ω terminator on the CH1 input of the digitizing oscilloscope. Refer to Figure 4–13.

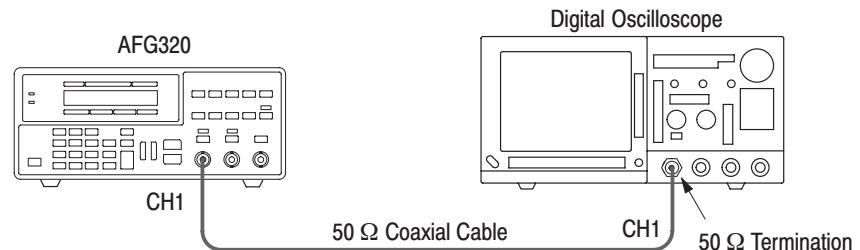

Figure 4-13: Initial Test Hookup

15. Set the oscilloscope controls as shown in Table 4-14.

Table 4-14: Oscilloscope settings

Function	Setting
CH 1 Vertical	
Coupling	DC
Scale	0.2 V/DIV
Input Impedance	1 MΩ
Horizontal	
Sweep	20 μs (adjust for best display)
Trigger	
Source	CH 1
Coupling	DC
Slope	Positive
Level	+100 mV
Mode	Auto

16. Select INITIALIZE in the SYSTEM menu on the function generator to initialize the system. Press the buttons on the front panel in the following order:

SHIFT → PHASE → < button until INITIALIZE is displayed → ENTER
→ ENTER

17. Press the CH1 button above the BNC connector to set the waveform output to on.

18. Press MODUL button on the front panel.

- 19.** Change the modulation type and check the modulation output listed in the table below.

To change the modulation type on the function generator, place the cursor on the name of the modulation in the **MODUL** item and press the **^** button. When the name of the desired modulation appears, press the **ENTER** button to confirm the selection.

LCD Display in MODUL Column	Modulation Output Description
SWP	1 V _{p-p} , Sweep output of Sine wave
FM	1 V _{p-p} , FM modulation output of Sine wave
FSK	1 V _{p-p} , FSK modulation output of Sine wave (frequency alternates between 10 kHz and 100 kHz each 500 ms.)
AM	0.5 V _{p-p} , Continuous Sine wave

- 20.** Follow the steps below to check the CH2 modulation output.
- a.** Remove the BNC cable from CH1 connector on the front panel and connect it to the CH2 connector.
 - b.** Press the **CH2** button above the BNC connector to set waveform output to on.
 - c.** Press the **CH** button on the front panel to change the target channel to CH2.
 - d.** Check the modulation of the CH2 output using the same procedure described in Step 18 to 19. Note that there is no AM modulation function for the CH2 output.

This completes the performance verification procedures. If you require further assistance, contact your nearest Tektronix Service Center.



Adjustment Procedures



Adjustment Procedures

The AFG310 and AFG320 Arbitrary Function Generators do not require any adjustments.



Maintenance

Maintenance

This section contains the information needed to do periodic and corrective maintenance on the AFG310 and AFG320 Arbitrary Function Generators . The following subsections are included:

- *Preparation* — Introduction plus general information on preventing damage to internal modules when doing maintenance.
- *Inspection and Cleaning* — Information and procedures for inspecting the AFG310 and AFG320 Arbitrary Function Generators and cleaning its external and internal modules.
- *Troubleshooting* — Information for isolating failed modules. Included are instructions for operating the internal diagnostic routines and troubleshooting tree. The tree makes use of these internal diagnostic routines to speed fault isolation to a module.

Related Maintenance Procedures

The following sections contain information and procedures related to maintenance.

- The *Operating Information* section covers instructions useful when operating and trouble shooting the AFG310 and AFG320 Arbitrary Function Generators. It also explains the service strategy and lists options for obtaining maintenance service and for replacing failed modules.
- The *Theory of Operation* section contains a circuit description at the module, or block level.
- The *Performance Verification* section contains procedures that may be useful in isolating problems to modules by testing the performance of the AFG310 and AFG320 Arbitrary Function Generators.
- The *Adjustment Procedures* section explains that there are no adjustments.
- The *Diagrams* section contains a block diagram using individual modules as blocks and an interconnection diagram showing connections between the modules.
- The *Mechanical Parts List* section lists all field replaceable modules by part number.

Preparation

Before servicing this product, read the *Safety Summary* and *Introduction* at the front of the manual and the ESD information below.



CAUTION. *Static discharge can damage any semiconductor component in this generator.*

Preventing ESD

When performing any service which requires internal access to the AFG310 and AFG320 Arbitrary Function Generators, adhere to the following precautions to avoid damaging internal modules and their components due to electrostatic discharge (ESD):

- Minimize handling of static-sensitive modules.
- Transport and store static-sensitive modules in their static protected containers or on a metal rail. Label any package that contains static-sensitive modules.
- Discharge the static voltage from your body by wearing a grounded antistatic wrist strap while handling these modules. Do service of static-sensitive modules only at a static-free work station.
- Nothing capable of generating or holding a static charge should be allowed on the work station surface.
- Handle circuit boards by the edges when possible.
- Do not slide the modules over any surface.
- Avoid handling modules in areas that have a floor or work-surface covering capable of generating a static charge.

Susceptibility to ESD

Table 6–1 lists the relative susceptibility of various classes of semiconductors. Static voltages of 1 kV to 30 kV are common in unprotected environments.

Table 6–1: Relative susceptibility to static-discharge damage

Semiconductor classes	Relative susceptibility levels ¹
MOS or CMOS microcircuits or discrete circuits, or linear microcircuits with MOS inputs (most sensitive)	1
ECL	2
Schottky signal diodes	3
Schottky TTL	4
High-frequency bipolar transistors	5
JFET	6
Linear microcircuits	7
Low-power Schottky TTL	8
TTL (least sensitive)	9

¹ Voltage equivalent for levels (voltage discharged from a 100 pF capacitor through resistance of 100 ohms):

1 = 100 to 500 V	6 = 600 to 800 V
2 = 200 to 500 V	7 = 400 to 1000 V (est.)
3 = 250 V	8 = 900 V
4 = 500 V	9 = 1200 V
5 = 400 to 600 V	

Inspection and Cleaning

Inspect and clean the instrument as often as operating conditions require. The collection of dirt can cause instrument overheating and breakdown. Dirt acts as an insulating blanket, preventing efficient heat dissipation. Dirt also provides an electrical conduction path that can cause an instrument failure, especially under high-humidity conditions.



CAUTION. *Avoid the use of chemical cleaning agents that might damage the plastics used in this instrument. Use only deionized water when cleaning the menu buttons or front-panel buttons. Use a ethyl alcohol solution as a cleaner and rinse with deionized water.*

Avoid the use of high pressure compressed air when cleaning dust from the interior of this instrument. (High pressure air can cause ESD.) Instead, use low pressure compressed air (about 9 psi).

Exterior Inspection

Using Table 6–2 as a guide, inspect the outside of the instrument for damage, wear, and missing parts. You should thoroughly check instruments that appear to have been dropped or otherwise abused to verify correct operation and performance. Immediately repair defects that could cause personal injury or lead to further damage to the instrument.

Table 6–2: External Inspection Check List

Item	Inspect for	Repair action
Cabinet, front panel, and cover	Cracks, scratches, deformations, damaged hardware or gaskets.	Replace defective module.
Front-panel knobs	Missing, damaged, or loose knobs.	Repair or replace missing or defective knobs.
Connectors	Broken shells, cracked insulation, and deformed contacts. Dirt in connectors.	Replace defective modules. Clear or wash out dirt.
Carrying handle and cabinet feet	Correct operation	Replace defective module.
Accessories	Missing items or parts of items, bent pins, broken or frayed cables, and damaged connectors.	Replace damaged or missing items, frayed cables, and defective modules.

Cleaning the Instrument Exterior



WARNING. To avoid injury or death, unplug the power cord from line voltage before cleaning the instrument. To avoid getting moisture inside the instrument during external cleaning, use only enough liquid to dampen the cloth or applicator.

1. Remove loose dust on the outside of the instrument with a lint-free cloth.
2. Remove remaining dirt with a lint free cloth dampened in a general purpose detergent-and-water solution. Do not use abrasive cleaners.
3. Clean the monitor screen with a lint-free cloth dampened with either ethyl alcohol or, preferably, a gentle, general purpose detergent-and-water solution.

Inspection — Interior. Inspect the internal portions of the generator for damage and wear, using Table 6–3 as a guide. Defects found should be repaired immediately.



CAUTION. To prevent damage from electrical arcing, ensure that circuit boards and components are dry before applying power to the function generator.

Table 6–3: Internal inspection check list

Item	Inspect for	Repair action
Circuit boards	Loose, broken, or corroded solder connections. Burned circuit boards. Burned, broken, or cracked circuit-run plating.	Remove failed module and replace with a new module.
Resistors	Burned, cracked, broken, blistered condition.	Remove failed module and replace with a new module.
Solder connections	Cold solder or rosin joints.	Resolder joint and clean with ethyl alcohol.
Capacitors	Damaged or leaking cases. Corroded solder on leads or terminals.	Remove damaged module and replace with a new module from the factory.
Semiconductors	Burned, cracked, broken condition. Loosely inserted in sockets. Distorted pins.	Remove failed module and replace with a new module.
Wiring and cables	Loose plugs or connectors. Burned, broken, or frayed wiring.	Firmly seat connectors. Repair or replace modules with defective wires or cables.
Chassis	Dents, deformations, and damaged hardware.	Straighten, repair, or replace defective hardware.

Cleaning Procedure — Interior. Do the following steps to clean the generator interior:

1. Blow off dust with dry, low-pressure, deionized air (approximately 9 psi).
2. Remove any remaining dust with a lint-free cloth dampened in ethyl alcohol and rinse with warm deionized water. (A cotton-tipped applicator is useful for cleaning in narrow spaces and on circuit boards.)

STOP. *If, after doing steps 1 and 2, a module is clean upon inspection, skip the remaining steps.*

3. If steps 1 and 2 do not remove all the dust or dirt, the generator may be spray washed using a solution of ethyl alcohol by doing steps 4 through 8.
4. Gain access to the parts to be cleaned by removing easily accessible shields and panels.
5. Spray wash dirty parts with the ethyl alcohol and wait 60 seconds for the majority of the alcohol to evaporate.
6. Use hot (120° F to 140° F) deionized water to thoroughly rinse boards and components.
7. Dry all parts with low-pressure, deionized air.
8. Dry all components and assemblies in an oven or drying compartment using low-temperature (125° F to 150° F) circulating air.

Lubrication. There is no periodic lubrication required for this function generator.

Troubleshooting

This subsection contains information and procedures designed to help you isolate faulty modules in the AFG310 and AFG320 Arbitrary Function Generators.

This subsection consists of the following descriptions:

- Diagnostics
- Figure 6–6: Primary Troubleshooting Procedure

Power-on Diagnostics

The AFG310 and AFG320 Arbitrary Function Generators has power-on diagnostics that focus on verifying, and if needed, for isolating faulty modules.

Prerequisites: Power on the AFG310 and AFG320 Arbitrary Function Generators.

NOTE. Allow a 20-minute warm-up for the instrument to operate at its optimum precision.

1. Push the front panel switch labeled POWER to power on the instrument. See Figure 6–1. Make sure that the fan is turning.

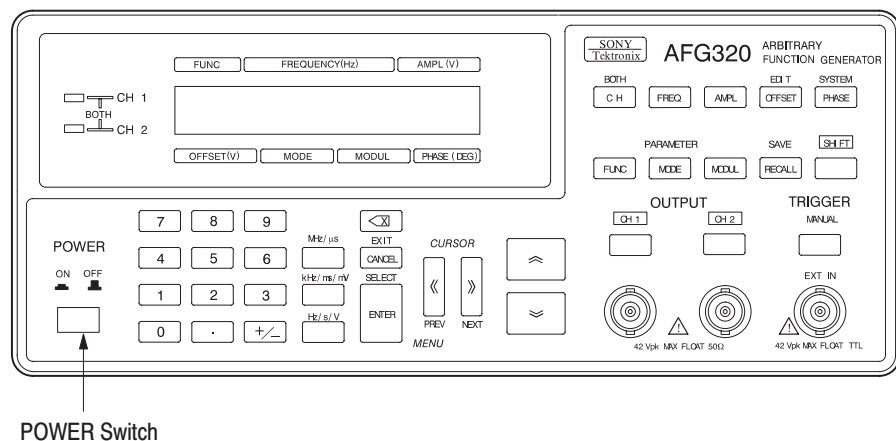

Figure 6–1: POWER switch

2. Check the results of the startup self test.

Power-on tests occur automatically each time you power on the instrument. See Figure 6-2 for the LCD display.

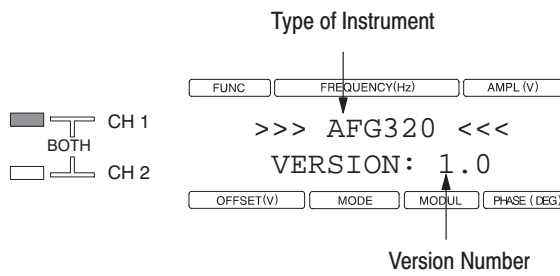

Figure 6-2: The LCD Display at Power On

The system continues to the default display after the start-up tests are complete.

If an error is detected, an error message is displayed on the first line, and the test item is displayed on the second line. See Figure 6-3. When multiple errors are detected, use the \vee and \wedge buttons to scroll through the failed test items. Although you can clear the error display state and use the instrument, the waveform output will not be reliable until you resolve the errors.

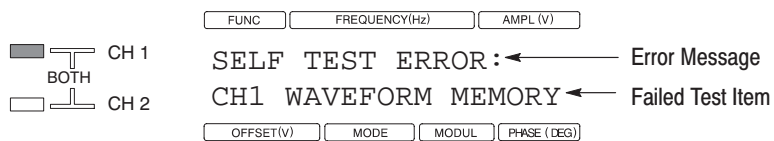

Figure 6-3: The LCD display when an error is found

To exit the error display, press the CANCEL/EXIT button.

NOTE. *The power-on self test consists of a subset of the tests performed by the SYSTEM menu SELF TEST item. Instrument calibration is not performed at power on unless an error is found in the internally stored calibration data. Use the SYSTEM menu self test and calibration items for more thorough self testing and calibration.*

This instrument uses flash memory as its internal nonvolatile memory. After this memory has been written about 1000 times, the instrument rewrites the whole chip. This provides wear leveling (distributed writing and periodic deletion/re-writing). The infrequent memory rewrite cycle increases the time required between power on and the point the instrument can be used by about ten seconds.

Troubleshooting Tree

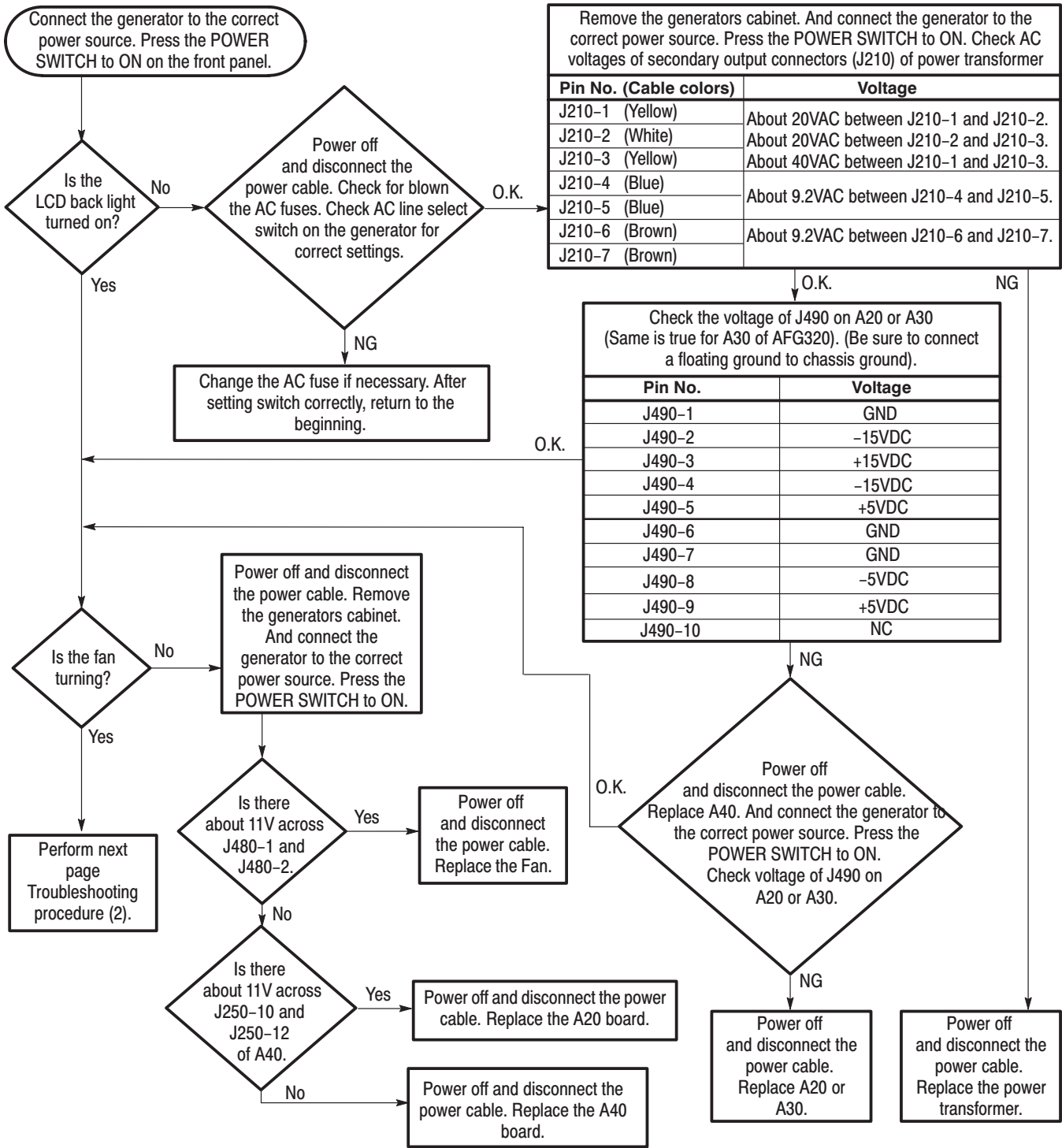

Figure 6-4: Troubleshooting procedure (1)

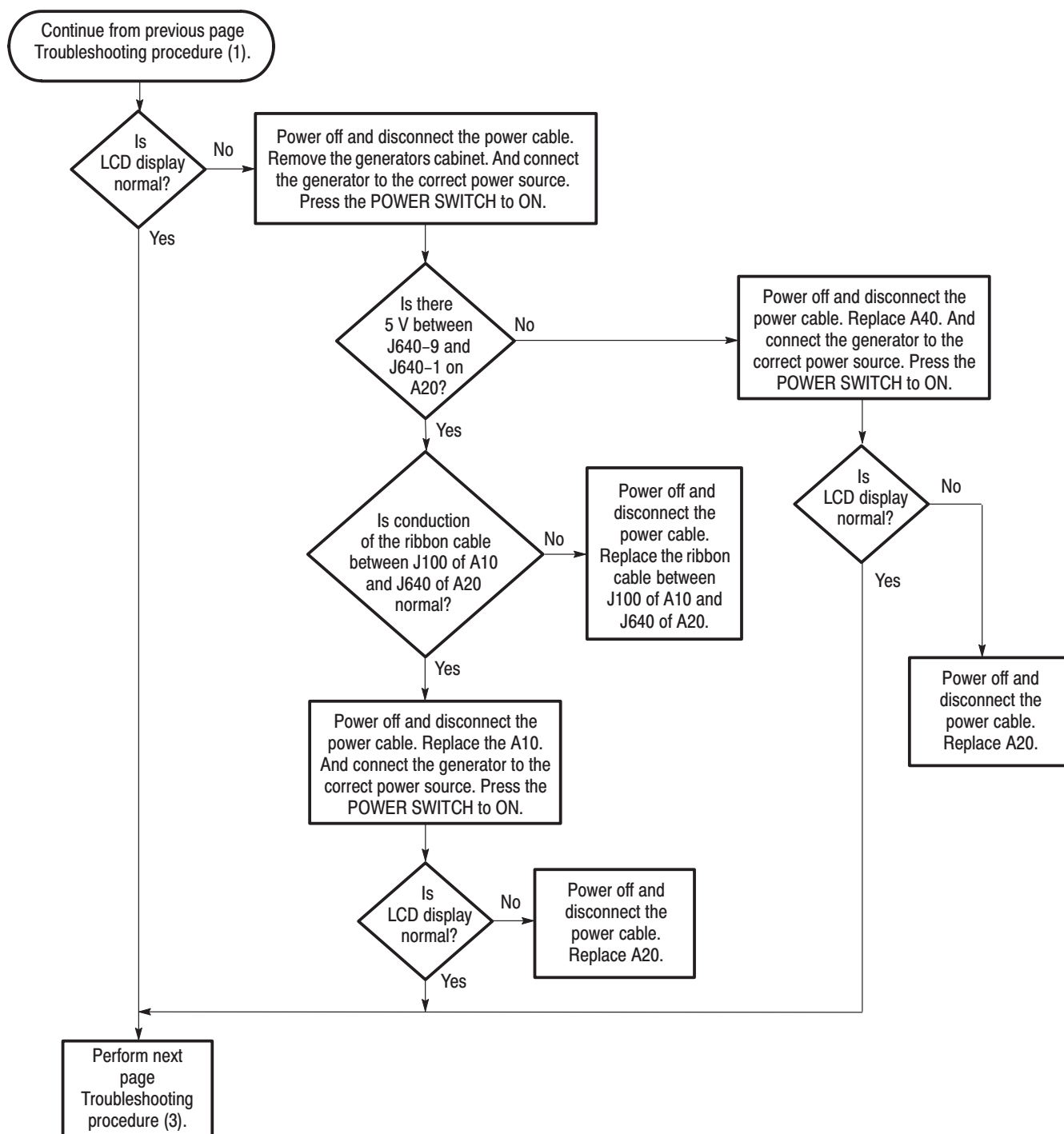

Figure 6-5: Troubleshooting procedure (2)

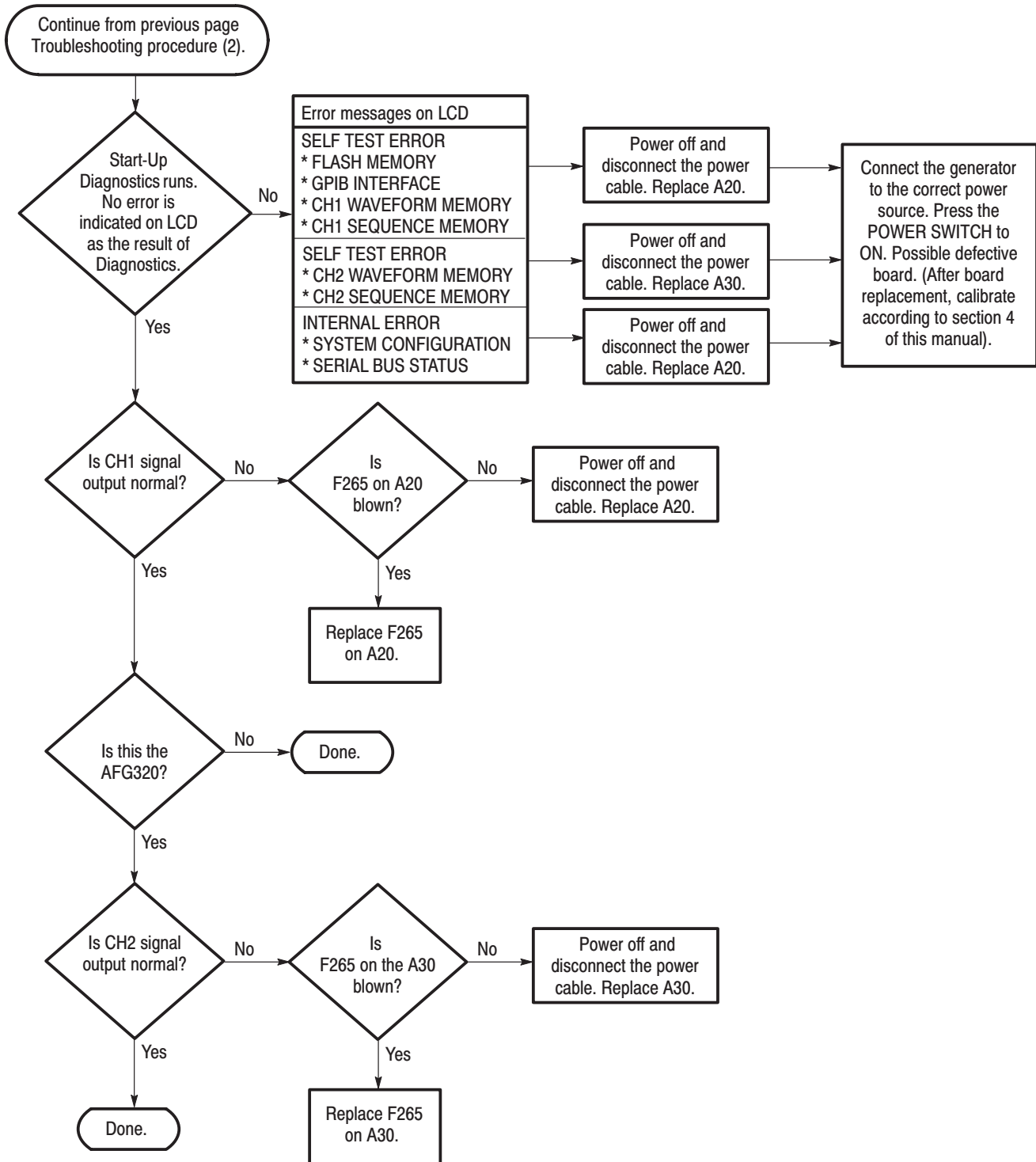

Figure 6-6: Troubleshooting procedure (3)

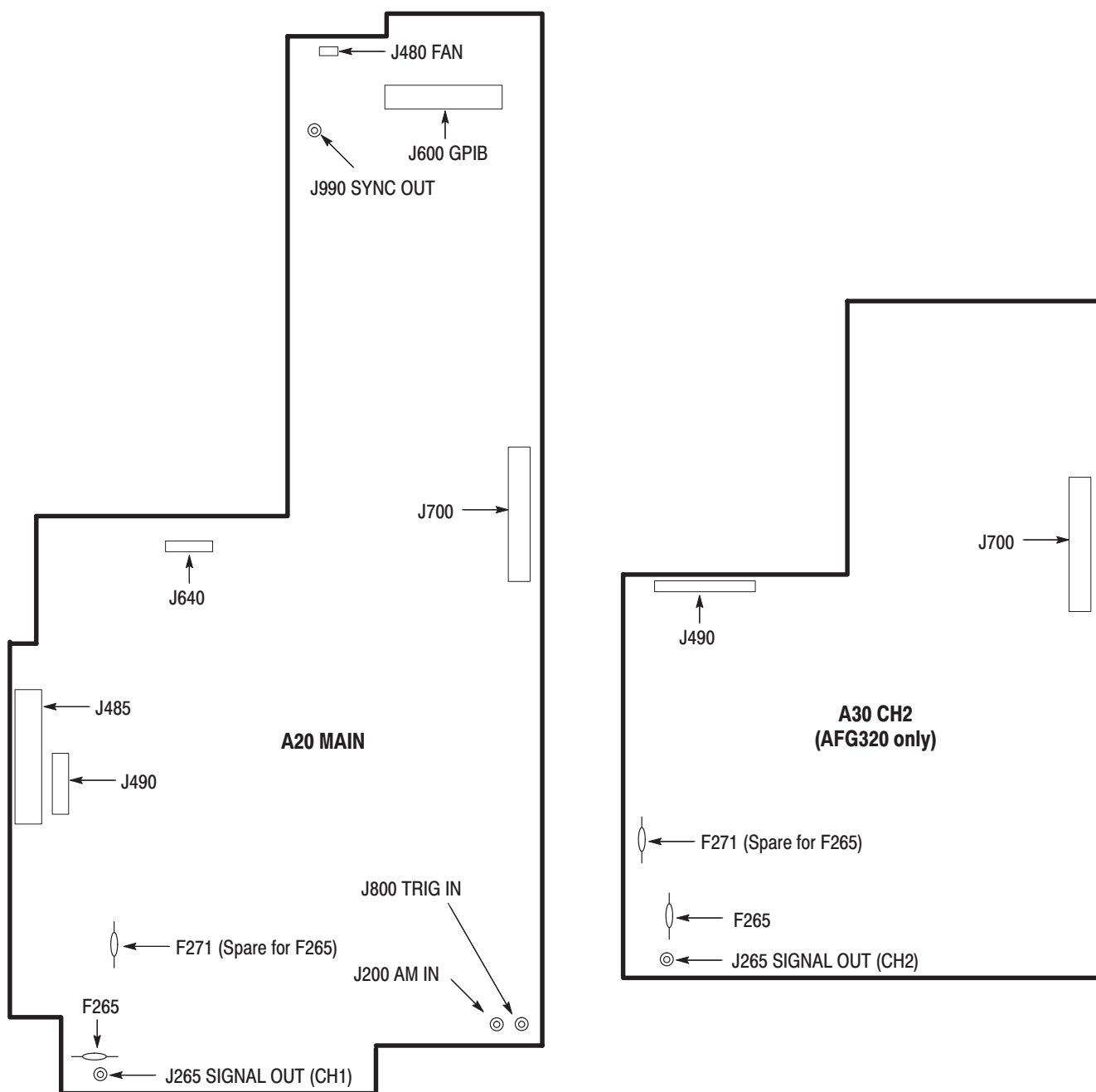

Figure 6-7: Connector location of A20 and A30 Board

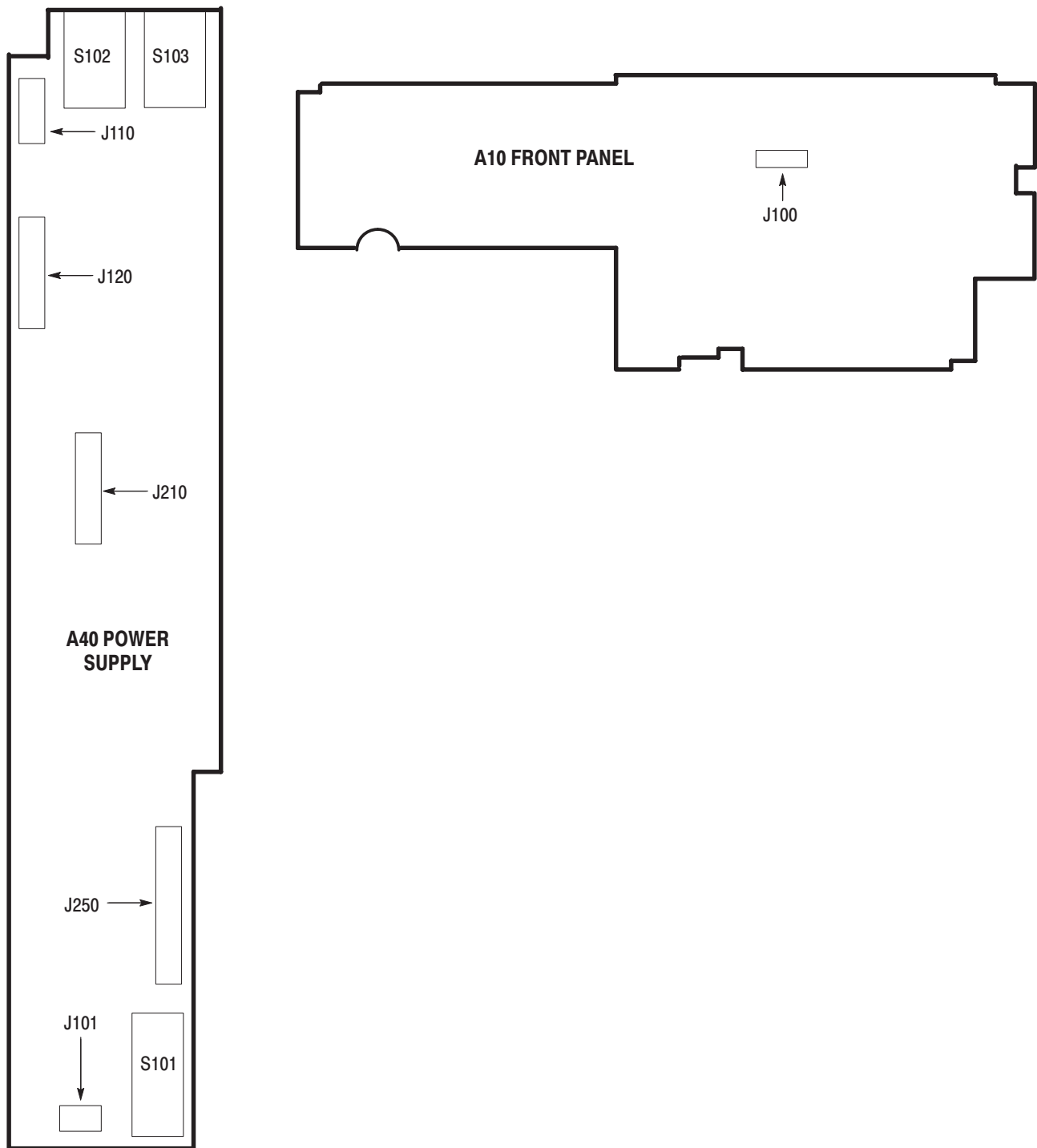

Figure 6-8: Connector location of A10 and A40 Board



Options and Accessories



Options and Accessories

This section describes the various options as well as the standard and optional accessories that are available for the AFG310 and AFG320 Arbitrary Function Generator.

Options

Tektronix will ship the options shown in Table 7-1:

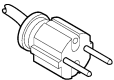
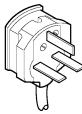
Table 7-1: Options

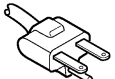
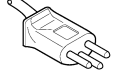
	Option #	Label	Description
	A1	Universal European power cord	220 V, 50 Hz power cord Fuse 5A (T) (IEC 127) Fuse Cap Cable Retainer
	A2	UK power cord	240 V, 50 Hz power cord Fuse 5A (T) (IEC 127) Fuse Cap Cable Retainer
	A3	Australian power cord	240 V, 50 Hz power cord Fuse 5A (T) (IEC 127) Fuse Cap Cable Retainer
	A4	North American power cord	240 V, 60 Hz power cord Cable Retainer
	A5	Switzerland power cord	220 V, 50 Hz power cord Fuse 5A (T) (IEC 127) Fuse Cap Cable Retainer

Standard Accessories

The waveform generator comes standard with the accessories listed in Table 7–2.

Table 7–2: Standard accessories

Accessory	Tektronix part number
AFG310 and AFG320 Arbitrary Function Generator User Manual	071-0175-XX
U.S. Power Cord 125 V/6A	161-0230-01

Optional Accessories

You can also order the optional accessories listed in Table 7–3.

Table 7–3: Optional accessories

Accessory	Tektronix part number
AFG310 and AFG320 Arbitrary Function Generator Service Manual	071-0176-XX
Wavewriter (Waveform Capture and Editing Software)	S3FT400
GPIB Cable	012-0991-00
50 Ω BNC Cable(61 cm (24 inch) long)	012-1342-00
50 Ω BNC Cable (double shielded)	012-1256-00
50 Ω Termination (50 $\Omega \pm 1 \Omega$, 2W)	011-0049-01
Rack Mount Kit (EIA)	016-1674-00



Diagrams

Diagrams

This section contains the following diagrams:

- Block Diagram for the AFG310 and AFG320 Arbitrary Function Generators
- Interconnect Diagram for the AFG310 and AFG320 Arbitrary Function Generators

Block diagrams show the modules and functional blocks in the function generator. Interconnect diagrams show how the modules in the function generator connect together.

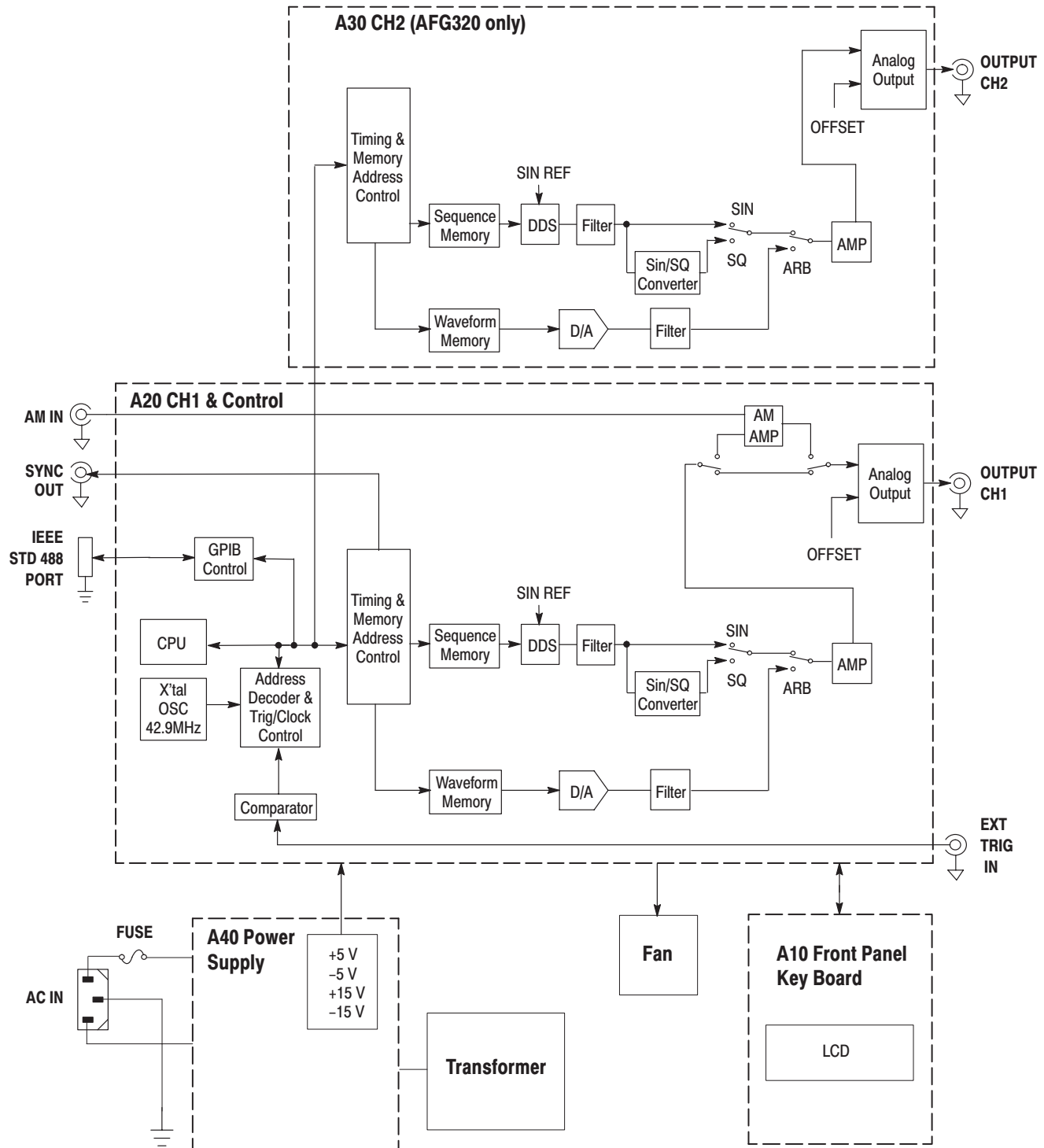

Figure 8-1: Block diagram

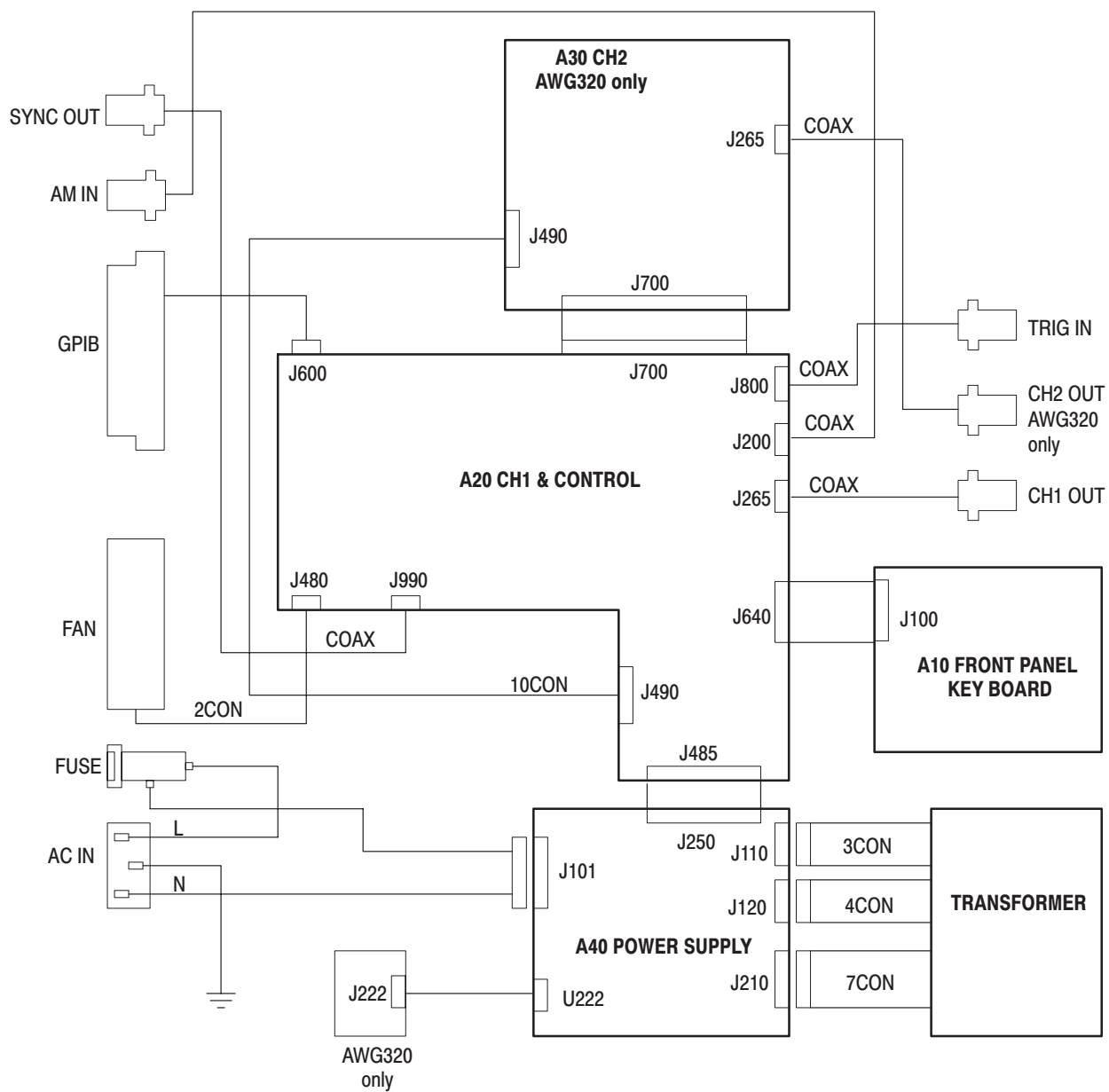

Figure 8-2: Interconnect diagram



Electrical Parts List



Electrical Parts List

The modules that make up this instrument are a combination of mechanical and electrical subparts. Therefore, all replaceable modules are listed in the *Mechanical Parts List* section of this manual.

Electrical Parts List



Mechanical Parts List

Replaceable Mechanical Parts

This section contains a list of the replaceable modules for the AFG310 and AFG320 Arbitrary Function Generator. Use this list to identify and order replacement parts.

Parts Ordering Information

Replacement parts are available through your local Tektronix field office or representative.

Changes to Tektronix instruments are sometimes made to accommodate improved components as they become available and to give you the benefit of the latest circuit improvements. Therefore, when ordering parts, it is important to include the following information in your order.

- Part number
- Instrument type or model number
- Instrument serial number
- Instrument modification number, if applicable

If you order a part that has been replaced with a different or improved part, your local Tektronix field office or representative will contact you concerning any change in part number.

Change information, if any, is located at the rear of this manual.

Part Number Revision Level

Tektronix part numbers contain two digits that show the revision level of the part. For most parts in this manual, you will find the letters XX in place of the revision level number.



When you order parts, Tektronix will provide you with the most current part for your product type, serial number, and modification (if applicable). At the time of your order, Tektronix will determine the part number revision level needed for your product, based on the information you provide.

Module Servicing Modules can be serviced by selecting one of the following three options. Contact your local Tektronix service center or representative for repair assistance.

Module Exchange. In some cases you may exchange your module for a remanufactured module. These modules cost significantly less than new modules and meet the same factory specifications. For more information about the module exchange program, call 1-800-TEK-WIDE, extension 6630.

Module Repair and Return. You may ship your module to us for repair, after which we will return it to you.

New Modules. You may purchase replacement modules in the same way as other replacement parts.

Using the Replaceable Parts List

This section contains a list of the mechanical and/or electrical components that are replaceable for the generator. Use this list to identify and order replacement parts. The following table describes each column in the parts list.

Parts List Column Descriptions

Column	Column Name	Description
1	Figure & Index Number	Items in this section are referenced by component number.
2	Tektronix Part Number	Use this part number when ordering replacement parts from Tektronix.
3 and 4	Serial Number	Column three indicates the serial number at which the part was first effective. Column four indicates the serial number at which the part was discontinued. No entries indicates the part is good for all serial numbers.
5	Qty	This indicates the quantity of parts used.
6	Name & Description	An item name is separated from the description by a colon (:). Because of space limitations, an item name may sometimes appear as incomplete. Use the U.S. Federal Catalog handbook H6-1 for further item name identification.
7	Mfr. Code	This indicates the code of the actual manufacturer of the part. (Code to name and address cross reference is located after this page.)
8	Mfr. Part Number	This indicates the actual manufacturer's or vendor's part number.

Abbreviations Abbreviations conform to American National Standard ANSI Y1.1-1972.

Mfr. Code to Manufacturer Cross Index The following table cross indexes codes, names, and addresses of manufacturers or vendors of components listed in the parts list.

Manufacturers Cross Index

Mfr. Code	Manufacturer	Address	City, State, Zip Code
00779	AMP INC.	CUSTOMER SERVICE DEPT PO BOX 3608	HARRISBURG, PA 17105-3608
060D9	UNITREK CORPORATION	3000 COLUMBIA HOUSE BLVD, SUITE 1 20	VANCOUVER, WA 98661
0KB01	STAUFFER SUPPLY CO	810 SE SHERMAN	PORTLAND, OR 97214-4657
24931	BERG ELECTRONICS INC	RF/COAXIAL DIV 2100 EARLYWOOD DR PO BOX 547	FRANKLIN, IN 46131
61935	SCHURTER INC	1016 CLEGG CT PO BOX 750158	PETALUMA, CA 94975-0158
80009	TEKTRONIX INC	14150 SW KARL BRAUN DR PO BOX 500	BEAVERTON, OR 97077-0001
TK0191	SONY/TEKTRONIX	PO BOX 5209 TOKYO INTERNATIONAL	TOKYO, JP 100-31
TK0BD	TAISHO ELECTRIC IND CO LTD	5-28-16 OKUSAWA SETAGAYA-KU	TOKYO JAPAN,
2W733	BELDEN WIRE & CABLE COMPANY	2200 US HWY 27 SOUTH PO BOX 1980	RICHMOND, IN 47374
S3109	FELLER U.S. CORPORATION	72 VERONICA AVE UNIT #4	SOMERSET, NJ 08873
TK1373	PATELEC-CEM	10156 TORINO VAICENTALLO 62/456	ITALY,
TK2541	AMERICOR ELECTRONICS LTD	UNIT-H 2682 W COYLE AVE	ELK GROVE VILLAGE, IL 60007

Replaceable Parts List (AFG310)

Fig. & Index Number	Tektronix Part Number	Serial No. Effective	Serial No. Discont'd	Qty	Name & Description	Mfr. Code	Mfr. Part Number
1-1	333-4277-00			1	PANEL, FRONT: POLYCARBONATE (AFG310)	80009	200-0444-00
-2	331-0574-00			1	WINDOW: CH1, MMA	80009	334-0573-00
-3	200-4444-00			1	COVER, FRONT: POLYCARBONATE	TK0191	200-4444-00
-4	260-2704-00			1	SWITCH, SLIDE: SPST,100MA,50VDC,8POS,16DIP,WASHABLE TYPE FJSK	TK0191	260-2704-00
-5	671-4441-XX			1	CIRCUIT BD ASSY: A10 FRONT 389-A378-XX WIRED	TK0191	671-4441-XX
-6	131-0955-00			1	CONN,RF JACK: BNC, 50 OHM, FEMALE,STR, SLDR, CUP/FRONT PNL, GOLD, SLDR CUP	00779	87-334-017
-7	131-1315-01			1	CONN,RF JACK: BNC, 50 OHM, FEMALE, STR, PELTOLA, PANEL MOUNT	24931	28JR306-1

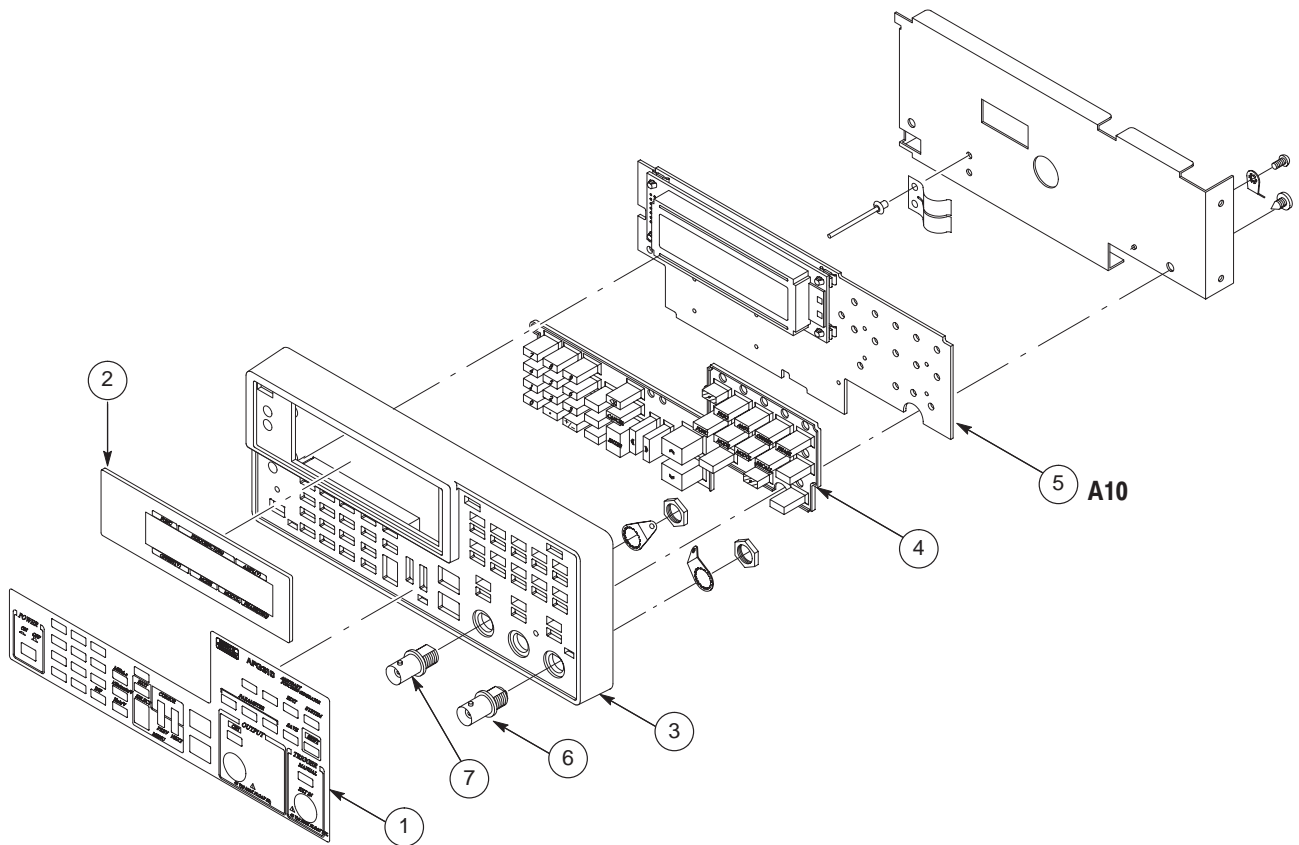

Figure 10-1: Front Panel (AFG310)

Replaceable Parts List (AFG320)

Fig. & Index Number	Tektronix Part Number	Serial No. Effective	Serial No. Discont'd	Qty	Name & Description	Mfr. Code	Mfr. Part Number
2-1	333-4299-00			1	PANEL, FRONT: POLYCARBONATE (AFG320)	TK0191	333-4277-00
-2	331-0573-00			1	WINDOW: CH2 MMA	TK0191	331-0574-00
-3	200-4444-00			1	COVER, FRONT: POLYCARBONATE	TK0191	200-4444-00
-4	260-2704-00			1	SWITCH, SLIDE: SPST,100MA,50VDC,8POS,16DIP,WASHABLE TYPE FJSK	TK0191	260-2704-00
-5	671-4441-XX			1	CIRCUIT BD ASSY: A10 FRONT 389-A378-XX WIRED	TK0191	671-4441-XX
-6	131-0955-00			1	CONN,RF JACK: BNC, 50 OHM, FEMALE,STR, SLDR, CUP/FRONT PNL, GOLD, SLDR CUP	00779	87-3334-017
-7	131-1315-01			2	CONN,RF JACK: BNC, 50 OHM, FEMALE, STR, PELTORA, PANEL MOUNT	24913	28JR306-1

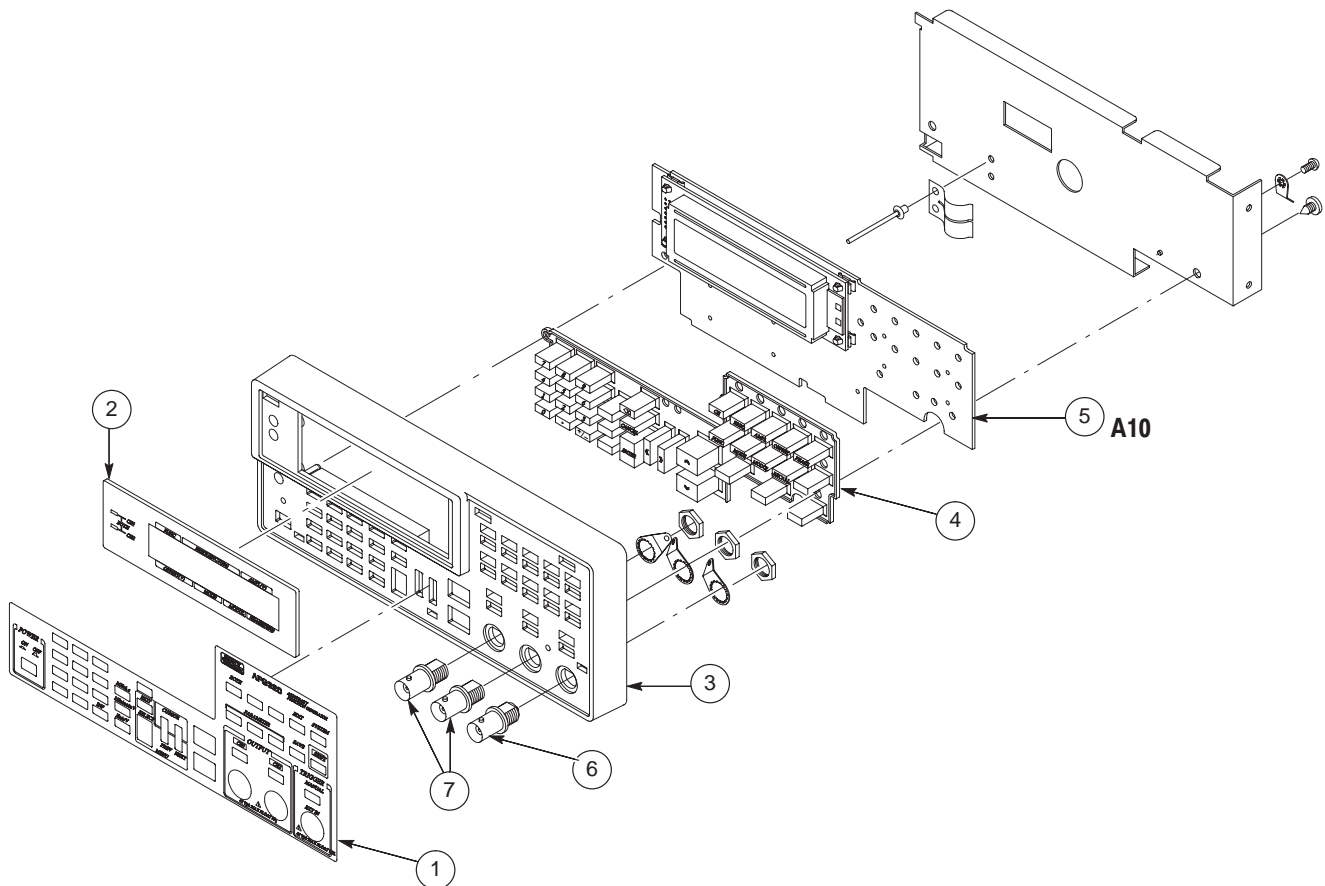

Figure 10-2: Front Panel (AFG320)

Replaceable Parts List (AFG310)

Fig. & Index Number	Tektronix Part Number	Serial No. Effective	Serial No. Discont'd	Qty	Name & Description	Mfr. Code	Mfr. Part Number
3-1	671-4460-XX			1	CIRCUIT BD ASSY: A40 POWER SUPPLY AFG310, 389-A390-XX WIRED	TK0191	671-4460-XX
-2	220-0209-00			4	NUT, M4, STL, NI PL.W/EXT TOOHEDED WASHER	80009	220-0209-00
-3	120-2003-00			1	TRANSFORMER RF; 100/120/220/240V. 50/60Hz IN, 18.2V/2A, 8.1V/1.5A, 8.2V/1A OUT	TK0191	120-2003-00
-4	671-4454-XX			1	CIRCUIT BD ASSY: A20 MAIN, 389-A379-XX WIRED	TK0191	671-4454-XX
-5	348-1587-00			2	FOOT, CABNET: W/STAND	TK0191	348-1587-00
-6	211-0965-00			4	SCREW, MACHINE, M3X8MM L, PNH, STL, ZN, PL, CROSS REC	TK0191	211-0965-00
-7	204-0832-00			1	FUSE HOLDER	61935	031 1673 (FEU MODEL)
-8	211-0965-00			2	SCREW, MACHINE, M3X8MM L, PNH, STL, ZN, PL, CROSS REC	TK0191	211-0965-00
-9	119-6609-00			1	FILTER, RFI	80009	119-6609-00
-10	213-1113-00			2	SCREW, TPG: 4.5X10, BDGH, TYPE1, STL, ZNPL, CROSS REC	TK0191	213-1113-00
-11	129-1493-01			2	SPACER, POST:16.5MML X M3.5 X 6MM INT/M3 EXT, STL, 7MM OD	TK0191	129-1493-01
-12	131-6654-00			1	CONN, RF, JACK, BNC/PNL	80009	31-6654-00
-13	211-8800-50			1	SCREW, MACHINE: M4X5MM L, BDGH, STL, MFZN-C	80009	211-8800-50
-14	119-5862-00			1	FAN, TUBEAXIL: 119-4361-00 W/CABLE ASSY	TK0191	119-5862-00
-15	348-1599-00			2	FOOT, CABNET: REAR	TK0191	348-1599-00
-16	211-0965-00			2	SCREW, MACHINE: M3X8MM L, PNH, STL, ZN, PL, CROSS REC	TK0191	211-0965-00
-17	220-0194-00			1	NUT, PLATE: STL	TK0191	220-0194-00
-18	211-0751-00			3	SCREW, MACHINE: M3X8MM L, PNH, STL, CROSS REC	OKB01	211-0751-00
-19	211-0751-00			8	SCREW, MACHINE: M3X8MM L, PNH, STL, CROSS REC	OKB01	211-0751-00
-20	159-0333-00			2	FUSE, WIRE-LEAD: A20 F265, F271, AXI, 0.25A, 125V, FAST	80009	159-0333-00
-21	163-1103-00			1	IC, MEMORY: CMOS, EPROM, PRGM, V2.1, U560	TK0191	163-1103-00
-22	159-0022-01			1	FUSE, CARTRIDGE: 3AG, 1A, 250V, FAST BLOW,	80009	159-0022-01
	159-0413-00			1	FUSE, CARTRIDGE: DIN, 0.5A, TIMELAG, IEC, AFG310,	TK0191	159-0413-00
	159-0417-00			1	FUSE, CARTRIDGE: 3AG, 0.5A, 250V, FAST	TK0191	159-0417-00
-23	200-2264-00			1	CAP, FUSEHOLDER: 3AG FUSES	61935	FEK 031 1666
	200-2265-00			1	CAP, FUSEHOLDER: 5 X 20MM FUSES	61935	031.1663

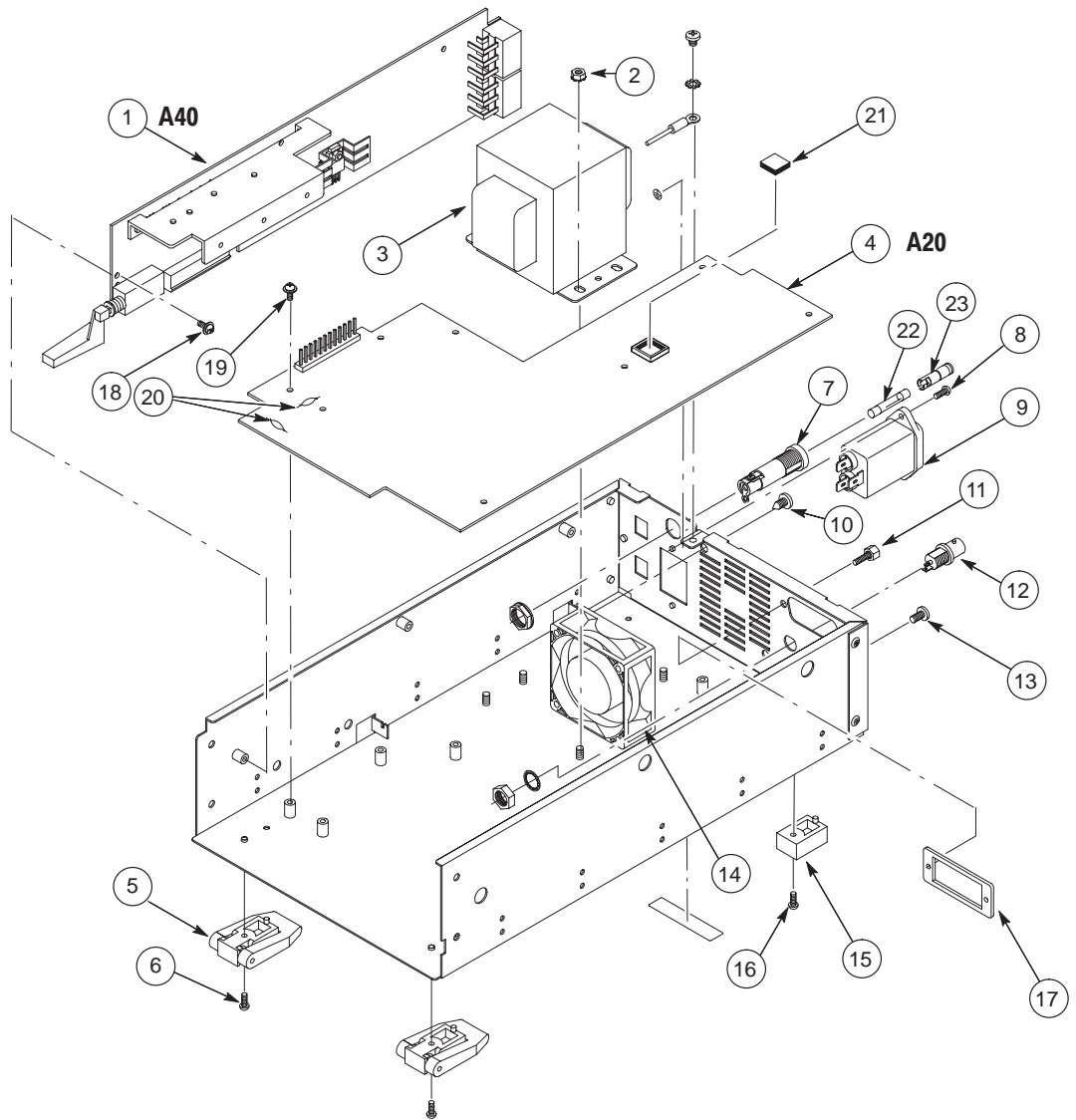

Figure 10-3: Chassis (AFG310)

Replaceable Parts List (AFG320)

Fig. & Index Number	Tektronix Part Number	Serial No. Effective	Serial No. Discont'd	Qty	Name & Description	Mfr. Code	Mfr. Part Number
4-1	671-4455-XX			1	CIRCUIT BD ASSY: A40 POWER SUPPLY, AFG320	TK0191	671-4455-XX
-2	220-0209-00			4	NUT, M4, STL, NI PL.W/EXT TOOHEDED WASHER	80009	220-0209-00
-3	120-2003-00			1	TRANSFORMER RF; 100/120/220/240V. 50/60Hz IN, 18.2V/2A, 8.1V/1.5A, 8.2V/1A OUT	TK0191	120-2003-00
-4	671-4454-XX			1	CIRCUIT BD ASSY: A20 MAIN, 389-A379-XX WIRED	TK0191	671-4454-XX
-5	348-1587-00			2	FOOT, CABNET: W/STAND	TK0191	348-1587-00
-6	211-0965-00			4	SCREW, MACHINE, M3X8MM L, PNH, STL, ZN, PL, CROSS REC	TK0191	211-0965-00
-7	204-0832-00			1	FUSE HOLDER	61935	031 1673 (FEU MODEL)
-8	211-0965-00			2	SCREW, MACHINE, M3X8MM L, PNH, STL, ZN, PL, CROSS REC	TK0191	211-0965-00
-9	119-6009-00			1	FILTER, RF1	80009	119-6009-00
-10	213-1113-00			2	SCREW, TPG: 4.5X10, BDGH, TYPE1, STL, ZNPL, CROSS REC	TK0191	213-1113-00
-11	129-1493-01			2	SPACER,POST:16.5MML X M3.5 X 6MM INT/M3 EXT,STL,7MM OD	TK0191	129-1493-01
-12	131-6654-00			2	CONN, RF, JACK, BNC/PNL	80009	131-6654-00
-13	211-8800-50			1	SCREW, MACHINE: M4X5MM L, BDGH, STL, MFZN-C	80009	211-8800-50
-14	119-5862-00			1	FAN, TUBEAXIL: 119-4361-00 W/CABLE ASSY	TK0191	119-5862-00
-15	348-1599-00			2	FOOT, CABNET: REAR	TK0191	348-1599-00
-16	211-0965-00			2	SCREW, MACHINE: M3X8MM L, PNH, STL, ZN, PL, CROSS REC	TK0191	211-0965-00
-17	220-0194-00			1	NUT, PLATE: STL	TK0191	220-0194-00
-18	211-0751-00			3	SCREW, MACHINE: M3X8MM L, PNH, STL, CROSS REC	OKB01	211-0751-00
-19	211-0751-00			8	SCREW, MACHINE: M3X8MM L, PNH, STL, CROSS REC	OKB01	211-0751-00
-20	671-4456-XX			1	CIRCUIT BD ASSY: A30 (AFG320 ONLY)	TK0191	671-4456-XX
-21	159-0333-00			4	FUSE, WIRE-LEAD: A20/A30 F265,F271,AXI, 0.25A, 125V, FAST	80009	159-0333-00
-22	163-1103-00			1	IC,MEMORY:CMOS,EPROM,PRGM,V2.1, U560	TK0191	163-1103-00
-23	159-0022-01			1	FUSE,CARTRIDGE:3AG,1A,250V,FAST BLOW,	80009	159-0022-01
	159-0413-00			1	FUSE,CARTRIDGE:DIN,0.5A,TIMELAG,IEC,AFG310,	TK0191	159-0413-00
	159-0417-00			1	FUSE,CARTRIDGE:3AG, 0.5A, 250V, FAST	TK0191	159-0417-00
-24	200-2264-00			1	CAP,FUSEHOLDER:3AG FUSES	61935	FEK 031 1666
	200-2265-00			1	CAP,FUSEHOLDER:5 X 20MM FUSES	61935	031.1663
-25	671-A508-XX			1	CIRCUIT BD ASSY:A60 CH2 REGURATOR (AFG320 ONLY)	TK0191	671-A508-xx

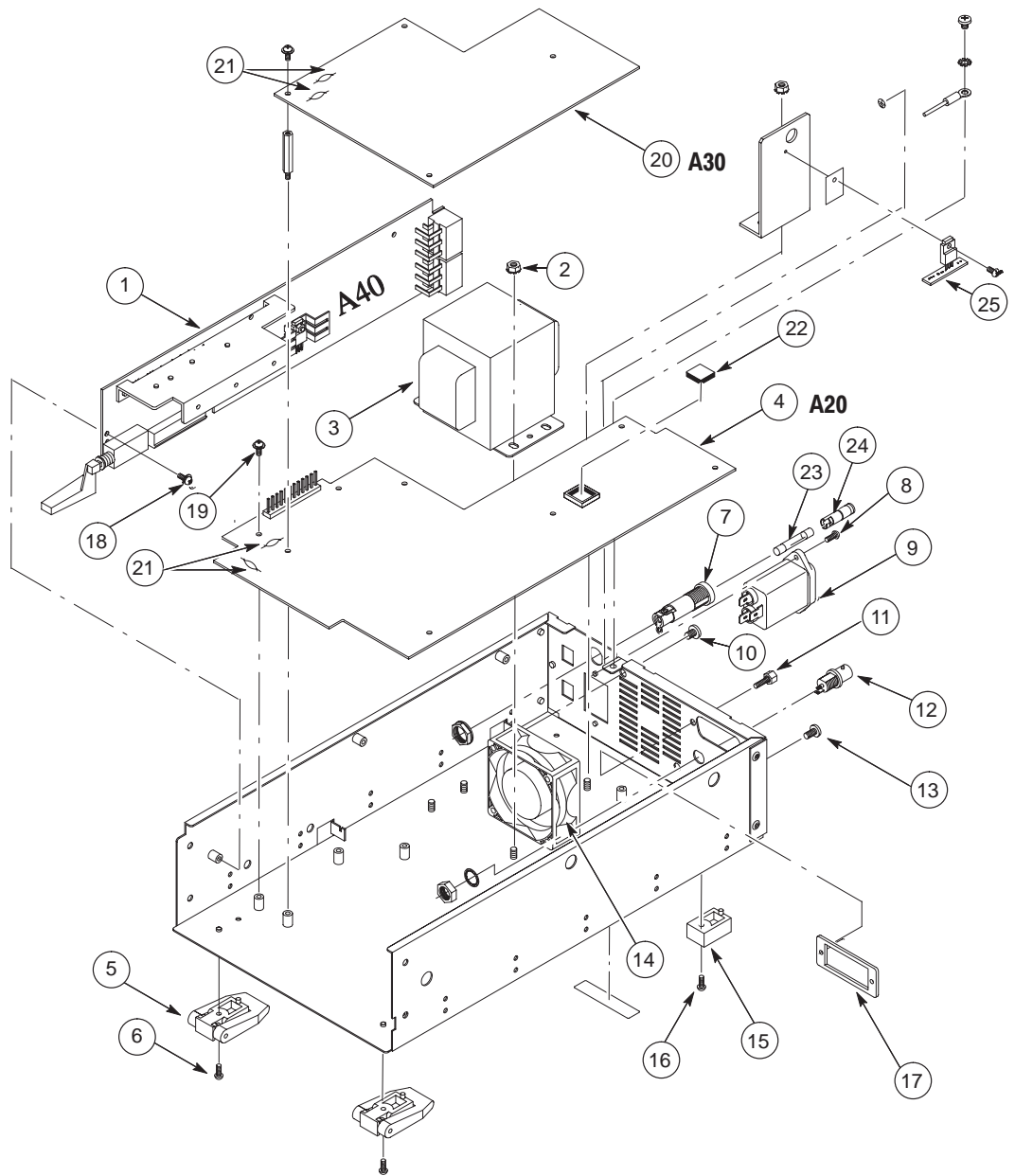

Figure 10-4: Chassis (AFG320)

Replaceable Parts List

Fig. & Index Number	Tektronix Part Number	Serial No. Effective	Serial No. Discont'd	Qty	Name & Description	Mfr. Code	Mfr. Part Number
5-1	390-1187-01			1	CABINET: STEEL	TK0191	390-1187-XX
-2	211-0960-00			2	SCREW, MACHINE: M4X10MM L, FLH, STL, MFZN-C, CROSS REC	TK0191	211-0960-00
-3				2	COVER		
-4	367-0504-00			1	HANDLE, CARRYING: 268MM L (CONTAINS ITEM NUMBER 3 ABOVE)	TK0191	367-0504-00

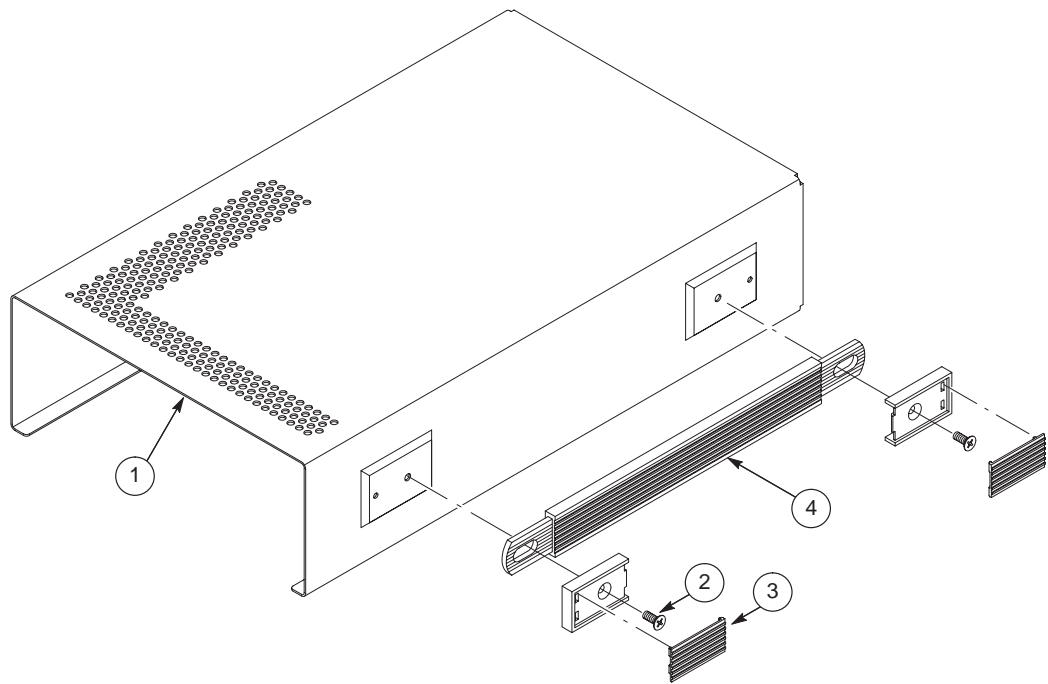

Figure 10-5: Cabinet

Replaceable Parts List

Fig. & Index Number	Tektronix Part Number	Serial No. Effective	Serial No. Discont'd	Qty	Name & Description	Mfr. Code	Mfr. Part Number
5-1	366-0800-00			1	PUSH BUTTON: POWER, POLYCARBONATE	TK0191	366-0800-00
-2	211-0959-00			4	SCREW, MACHINE: M4X5MM L, BDGH, STL ZN PL, CROSS REC	TK0191	211-0959-00
-3	200-4441-00			1	COVER, REAR; POLYCARBONATE	TK0191	200-4441-00
-4	211-8800-50			2	SCREW, MACHINE: M4X8MM L, BDGH, STL, MFZN-C	TK0191	211-8800-50

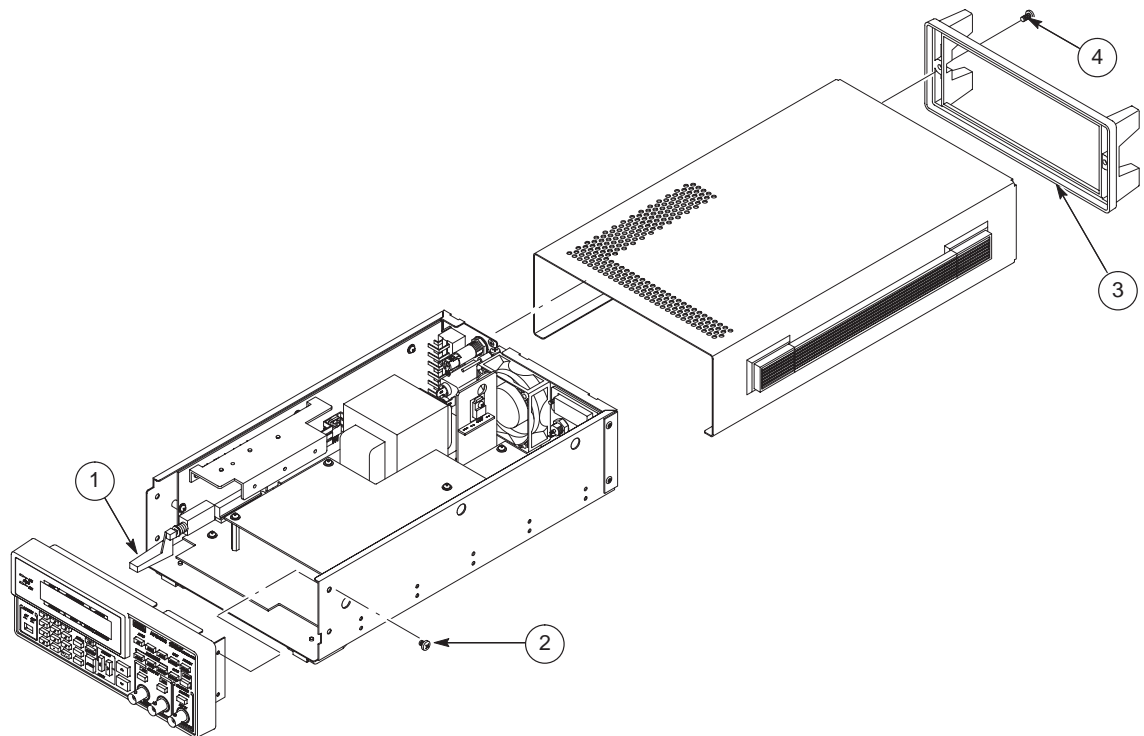

Figure 10-6: Final (AFG320)

Replaceable Parts List

Fig. & Index Number	Tektronix Part Number	Serial No. Effective	Serial No. Discont'd	Qty	Name & Description	Mfr. Code	Mfr. Part Number
	174-3934-00			1	CA ASSY, A20-J600, GPIB, FLAT	TK0191	174-3934-00
	174-3935-00			2	CA ASSY, SP, ELEC: 50 OHM COAX, 15CM L,8-N, W/HLDR A20-J990, A20-J800	TK0191	174-3935-00
	174-4088-00			1	CA ASSY, SP, ELEC: 50 OHM COAX, A20-J200	TK0191	174-4088-00
	174-3936-00			1	CA ASSY, SP, ELEC: 64, 30AWG, 45MM L, FLAT, A30-J70 (USED IN ONLY AFG320)	TK0191	174-3936-00
	174-2801-00			1	CA ASSY, SP, ELEC: A30-J490, 10,AWG26	80009	174-2801-00
	174-3201-00			2	CA ASSY, RF: 50 OHM COAX, 20CML,: 9-1, W/PFLTOLA BOTH END (A20-J265, A30-J265) (USED IN ONLY AFG320)	TK0191	174-3201-00
	174-3201-00			1	CA ASSY, RF: 50 OHM COAX, 20CML,: 9-1, W/PFLTOLA BOTH END (A20-J265) (USED IN ONLY AFG310)	TK0191	174-3201-00
	174-3937-00			1	CA ASSY, SP, ELEC: A10-J100, FLAT FLEX	TK0191	174-3937-00
STANDARD ACCESSORIES							
	071-0175-XX			1	MANUAL, TECH: USER, ENGLISH VERSION	TK0191	071-0175-XX
	161-0230-01			1	CABLE ASSY,PWR:3,18 AWG,92 L,SVT,TAN,60 DEG C,MC-6-3C/G X RTANG BME,10A/125V,	2W733	ORDER BY DESCRIPTION
	161-0104-06			1	CA ASSY,PWR:3,1.0MM SQ,250V/10A,2.5 METER,RTANG,IEC320,RCPT,EUROPEAN,SAFTEY CONTROLLED,	TK1373	ORDER BY DESCRIPTION
	161-0104-07			1	CA ASSY,PWR:3,1.0MM SQ,240V/10A,2.5 METER,RTANG,IEC320,RCPT X 13A,FUSED,UK PLUG,(13A FUSE),U	TK2541	ORDER BY DESCRIPTION
	161-0104-05			1	CA ASSY,PWR:3,1.0MM SQ,250V/10A,2.5 METER,RTANG,IEC320,RCPT,AUSTRALIA,SAFTEY CONTROLLED,	TK1373	161-0104-05
	161-0104-08			1	CA ASSY,PWR:3,18 AWG,250/10A,98 INCH L,RTANG,IEC320,RCPT X STR,NEMA 6-15P,US,SAFTEY CONTROLL	2W733	161-0104-08
	161-0167-00			1	CA ASSY,PWR:3,0.75MM SQ,250V/10A,2.5 METER,RTANG,IEC320,RCPT,SWISS,NO CORD GRIP,SAFTEY CONTR	S3109	ORDER BY DESCRIPTION
OPTIONAL ACCESSORIES							
	071-0176-XX			1	MANUAL, TECH: SERVICE, ENGLISH VERSION	TK0191	071-0176-XX
	075-0288-XX			1	MANUAL, TECH: INSTRUCTIONS FOR RACK MOUNT KIT 016-1674-XX; AFG300-OP	TK0191	075-0288-XX
	016-1674-00			1	FIELD INSTALLATION KIT OPTION-1R	TK0191	016-1674-00
	012-1342-00			1	CA ASSY,RF:COAXIAL,;RFD,50 OHM,24 L,BNC,MALE	060D9	012-1342-00
	012-1256-00			1	CABLE,INTCON 50 OHM COAX,98.0	TK0BD	012-1256-00
	012-0991-00			1	CABLE,INTCON SHLD CMPST,GPIB,;2 METER	00779	553577-3
	011-0049-01			1	TERMN,COAXIAL 50 OHM,2W,BNC	24931	28A123-1

